

SMART METERING & PRIVACY: EXISTING LAW AND COMPETING POLICIES

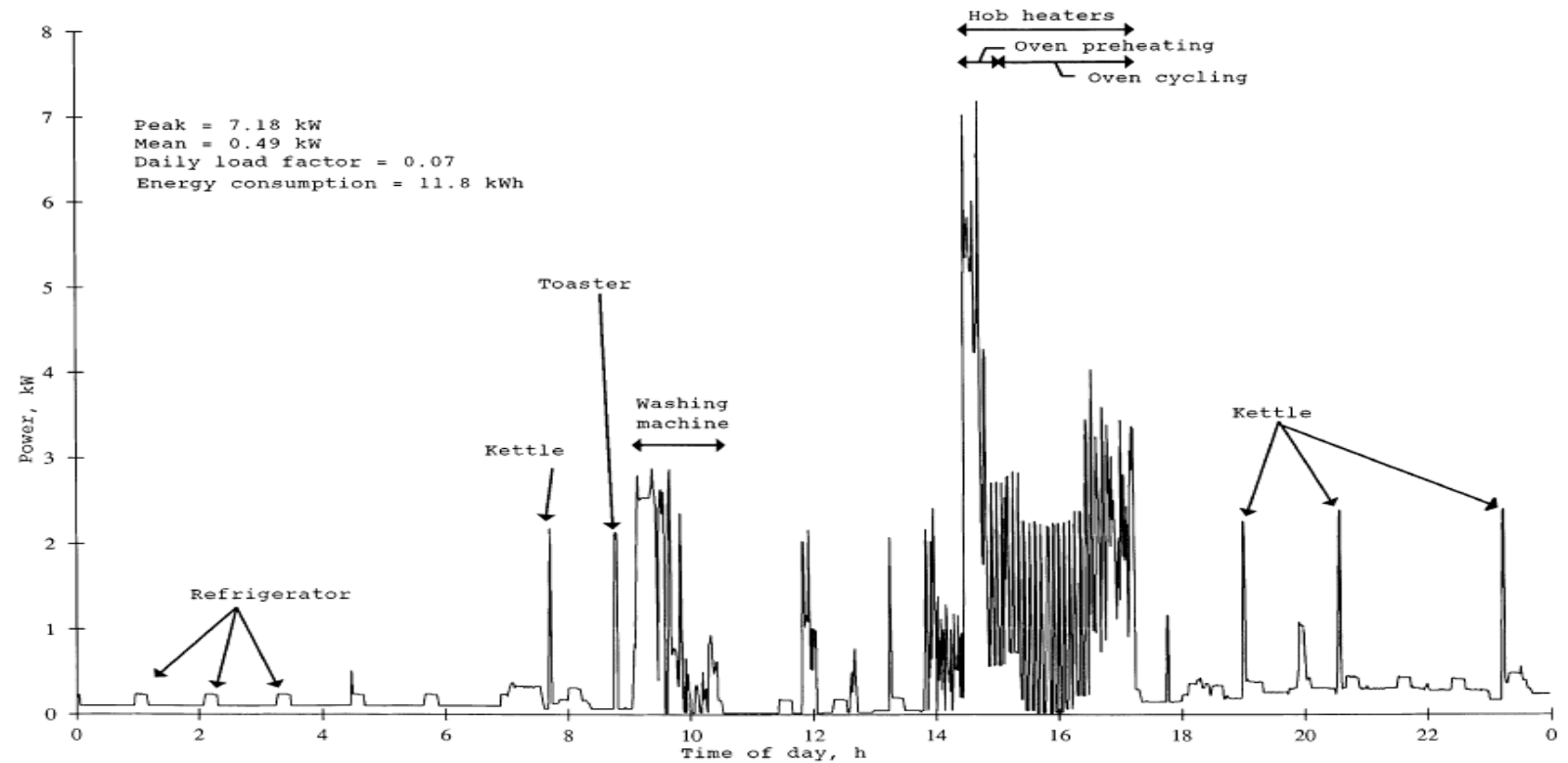

A REPORT FOR THE COLORADO PUBLIC UTILITIES COMMISSION

Elias Leake Quinn
Spring 2009

OVERVIEW

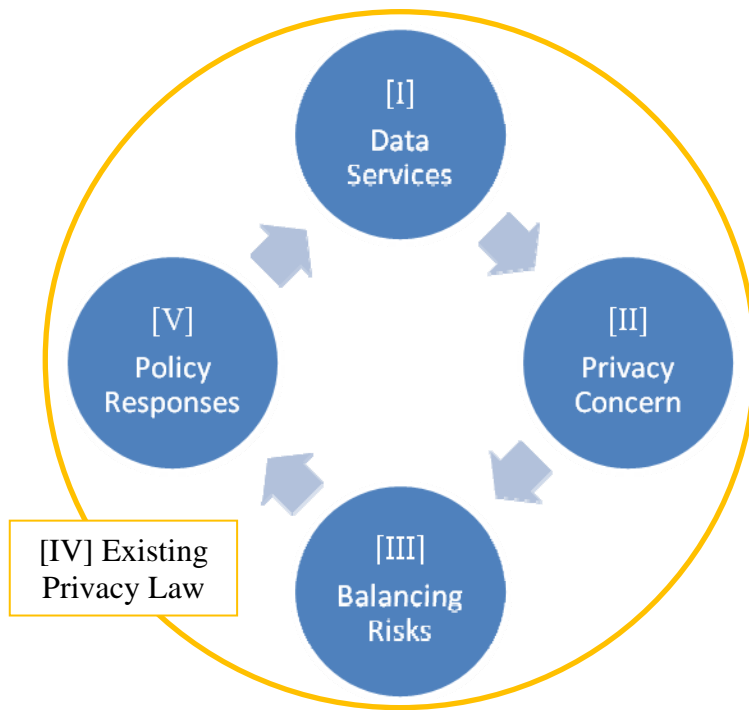

LIST OF ACRONYMS

AMI – Advanced metering infrastructure
CPNI – Customer proprietary network information
DSM – Demand-side management
EPSC – Energy performance savings contract
ESCO – Energy service company
EU – European Union
FCC – Federal Communications Commission
FERC – Federal Energy Regulatory Commission
HAN – Home area network
NALM – Non-intrusive appliance load monitor
NCSL – National Conference of State Legislatures
PUC – Public Utility Commission
REP – Retail electricity provider

Cover Graphic: G. Wood & M. Newborough, *Dynamic Energy-consumption Indicators for Domestic Appliances: Environment, Behavior, and Design*, 35 ENERGY AND BUILDINGS 821, 822 (2003).

EXECUTIVE SUMMARY

Advanced metering infrastructure (AMI or smart metering) is being installed throughout electric networks both in Colorado¹ and across the country.² From these smart meters, detailed information about consumer electricity usage will flow from residences and businesses to electric utilities. Instead of billing customers for their monthly draw, electric utilities will know what customers are using in half-hour, fifteen-minute, or even five-minute intervals.

Proper management of this new information pool could support energy efficiency efforts and demand-side management (DSM) initiatives.³ However, insufficient oversight of this information could also lead to unprecedented invasions of consumer privacy. Many intricate details of household life can be gleaned from information obtained via advanced metering infrastructure.

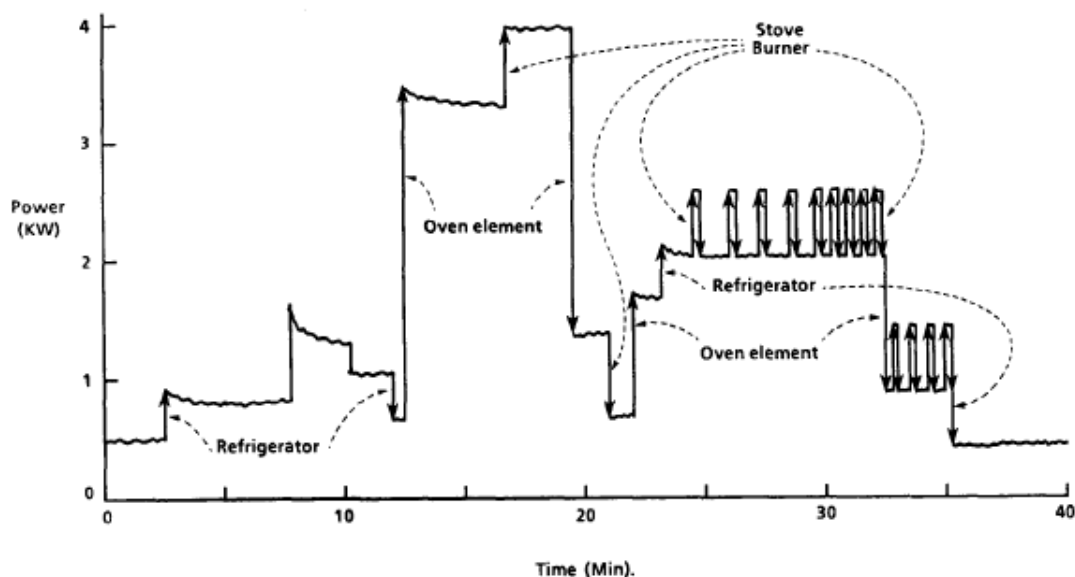

Example of an individual's load profile constructed using consecutive load measurements taken in small intervals with various appliance events identified.⁴

A complicated network of risks and concerns bears on this issue. The more information gathered, the better supported DSM initiatives, efficiency investments, and conservation efforts. Yet such efforts are antithetical to traditional utility incentive structures, which tie returns to electricity sales. The use and sale of this information might play a role in reforming the business model of electric utilities; indeed, smart grid information is a potential revenue stream heretofore unexplored.⁵ As such, the formulation of privacy regulations should be seen, not only as consumer protection, but as incentive regulation.

However, information control regimes that centralize smart grid information disclosures by giving principle control to the electric utility may work against innovation in service industries developing at the edge of the electric grid and provide new barriers to market entry. If privacy regulations make customer usage information is too difficult or expensive to obtain, the regulatory regime could dampen the rampant growth and evolution of a promising new sector for economic development. The balance struck among these various factors will define any privacy

concern related to smart grid information, which is ultimately founded on who has access with customer usage information, and what they can do with it.

The following illustrates how many of the issues surrounding smart grid development are integrated with one another, and how efforts to resolve these concerns might work cross-purposes:



The various interests converging on smart grid development are not strictly incompatible; a workable and perhaps even jointly beneficial compromise can be found. However, the integrated nature of these issues highlight that there is not a vision-neutral option before policy makers. Inaction on the collection of smart grid information controls favors some actors, while tailored regulation would likely favor others.

Additionally, these pressures urge that the privacy concerns be addressed earlier rather than later. First, privacy concerns are real, and should be addressed proactively in order to protect consumer privacy. Second and related, a salient privacy invasion—were it to happen and get press—could create significant opposition to smart grid deployment efforts. Third, information controls that govern which parties have access to smart grid information when, and what they can do with it, will be a critical part of the networking architecture and will inform—and constrain—viable business models for edge services.

Part I examines the technological capabilities and potential data services made possible by smart metering and other smart grid technologies. Part II lays out various aspects of the privacy concern cued by potential uses of collected smart meter data. Part III discusses the various interconnected risks and concerns posed by the smart metering issue. Part IV describes existing privacy laws and information protections in Colorado, within other states, and at the federal level. Part V discusses a suite of possible regulatory or policy strategies for protecting consumer privacy without sacrificing efficiency gains afforded electricity generation and distribution by the collection of consumer usage data. Each section begins with a summary of its contents.

The report concludes that comprehensive privacy protection requires a triptych of regulatory efforts:

- [1] Regulations setting consent requirements for the disclosure of smart meter customer information to third parties;
- [2] Requirements that both technological and procedural measures for the protection of customer data be in place as a prerequisite to gaining access to the data;
- [3] Requirements that parties holding customer information inform those customers in the event their information is stolen or accessed by unauthorized individuals.

¹ Xcel Energy, SmartGridCity, <http://www.xcelenergy.com/smartgrid/> (last visited Sept. 9, 2008); Xcel Energy, *SmartGridCity™: Design Plan for Boulder, Colo.*, available at <http://www.xcelenergy.com/smartgrid/media/pdf/SmartGridCityDesignPlan.pdf>; Advanced Metering Infrastructure (Black Hills Energy AMI Project Update), presented to the Colorado Public Utilities Commission Apr. 9, 2009, available at https://www.dora.state.co.us/pls/efi/efi_p2_v2_demo.show_document?p_dms_document_id=6690.

² The Federal Energy Regulatory Commission (FERC) reported that, all told, these efforts will result in the deployment of 52 million advanced metering devices over the next five to seven years. Federal Energy Regulatory Commission, *Assessment of Demand Response & Advanced Metering 2008*, Staff Report [hereinafter “FERC 2008 Demand Response Assessment”], at 14, available at www.ferc.gov/legal/staff-reports/12-08-demand-response.pdf. It should be noted that this estimate predated the stimulus package set forward under the Obama Administration that marked some \$11 billion for investment in smart grids.

³ Cf. the stated interest of the Colorado Public Utilities Commission in Docket No. 08I-113EG:

v. Can the regulatory incentive structure be changed to align a utility’s financial incentives to develop and support energy efficiency programs?

vi. Can the incentive structure be modified to heighten the utility’s incentives for management efficiency?

Colo. PUC Decision No. C08-0448, at 2–3 ¶ 5, as modified by Colo. PUC, Order on Scope of Investigatory Docket, Docket No. 08I-113EG, Decision No. C08-0640, June 24, 2008 [hereinafter Colo. PUC Decision No. C08-0640], at 6 ¶¶ 12–13.

⁴ George W. Hart, *Nonintrusive Appliance Load Monitoring*, 80 PROCEEDINGS OF THE IEEE 1870, 1871 (Dec. 1992) (“Power v. time (total load) shows step changes due to individual appliance events.”)

⁵ Due to the prevalence of copying technology and the negligible cost of making a copy, information goods such as smart meter information are, for all intents and purposes, non-rivalrous and non-excludable. Privacy regulations—along with technological protections such as information encryption—make information excludable and thereby turn it from what economists call a public good into a salable commodity.

CONTENTS

EXECUTIVE SUMMARY

- I. SMART METER DATA SERVICES:
 - A. Technological Capabilities
 - B. Information Uses
- II. THE PRIVACY CONCERN:
The Possibility of Invasion
- III. BALANCING RISKS:
Understanding the Stakes and Conflicting Policy Concerns
- IV. EXISTING PRIVACY LAW:
The Relevant Legal Landscape
 - A. Colorado Law
 - B. Comparative Analysis
 - C. Federal Law
- V. POTENTIAL POLICY RESPONSES:
Protecting Privacy without Sacrificing Energy Efficiency Development
 - A. Disclosure Consent Regulations
 - B. Information Protection Requirements
 - C. Notice Requirements
- VI. CONCLUSIONS

APPENDICES

- A. TECHNOLOGICAL BACKGROUNDER
- B. DATA USES & POTENTIAL INFORMATION CUSTOMERS

I. SMART METER DATA SERVICES

Summary

The information provided by smart meters and other smart grid technologies is unique in both its depth and breadth. If its collection and dissemination goes unchecked, such information has the potential to enable significant invasions into consumer privacy. At the same time, smart grid information is useful for facilitating demand response initiatives and the development of new business models in the nascent energy management industry. In addition to the myriad uses to which this information is already put, an electric utility, the likely clearing house for this information, could bundle consumer electricity usage data into data streams in several ways, tuning their efforts to both protect consumer privacy and supply a new revenue stream to help drive the transition to a model of electricity management rather than electricity sale.

Information is the backbone of the smart grid. The myriad ways in which information about consumer electricity usage can be collected and harnessed for more efficient and effective electricity provision has the potential not only to revolutionize the electricity industry, but to drive the development of a rich market of edge services, businesses focusing on the edge of the electric network providing consumer interfaces, electricity management tools, and the like. However, the very characteristics that make this information useful for environmental initiatives and network management make it potentially dangerous to privacy.

In order to examine the privacy consequences of smart grid development, it is important to first understand the technological capabilities and information extraction possibilities created by such metering infrastructure. Additionally, as intuitions surrounding privacy shift with the changing uses of data, privacy policy must consider not only the static portrait of relevant technology and law, but engage their dynamic realities and attempt to anticipate future developments. To this end, the historical development of technological capabilities is sketched out here, providing a glimpse at development vectors.

A. *Technological Capabilities*

The drive for high-resolution energy usage data from which to forecast load demand or optimize service led naturally to an investigation of individual appliances and their relative contribution—both in time and amount of draw—to the overall load. Traditionally, this meant the installation of cumbersome and rather intrusive monitoring equipment within customer homes, often involving “a monitoring point at each appliance of interest and wires . . . connecting each to a central data-gathering location.”¹ In the early 1980’s, researchers at MIT turned the research on its head with the development of the non-intrusive appliance load monitor

¹ George W. Hart, *Nonintrusive Appliance Load Monitoring*, 80 PROCEEDINGS OF THE IEEE 1870, 1871–72 (Dec. 1992).

(NALM),² which “reverses this balance[] with simple hardware but complex software for signal processing and analysis.”³ The NALM insight was simple in form, but profound in consequence: If a device could be appended to the existing metering infrastructure that would allow for real-time logging of electricity consumption (the simple hardware), the information of appliance use might be able to be reconstructed from the overall load data (through the application of complex software) and thereby remove the need for intruding within the residential space and installing new equipment within the home.

In order to disaggregate a customer’s electricity usage profile into its constituent appliance events, researchers began compiling libraries of appliance load signatures that could be matched to signals found within the noise of a customer’s aggregated electricity use. Though initially thought a daunting task to work backwards from an appliance’s demand to the identity of the appliance itself, the load signatures of various appliance categories are surprisingly unique,⁴ and an impressive amount of detail concerning customer usage habits could be discerned from NALM-generated information.

NALMs were ever research tools, set up to monitor only a small number of customers in order to facilitate load forecasting and management. However, smart meters allow for the collection and communication of highly detailed electricity usage information in much the same way as did the NALM. However, unlike NALMs, smart meters are being deployed throughout entire electricity distribution networks. Indeed, the Federal Energy Regulatory Commission (FERC) recently reported that, all told, 52 million smart meters would be installed throughout the country over the next five to seven years.⁵ Smart-metered information, collected at levels as fine as one-minute intervals, can be disaggregated into its constituent appliance events, allowing both consumers and utilities (and anyone else with access to the information) to see exactly what makes up an individual household’s electricity demands:

² Christopher Laughman et al., *Advanced Nonintrusive Monitoring of Electric Loads*, IEEE POWER AND ENERGY 56 (Mar./Apr. 2003). Non-intrusive appliance load monitors do not have a single, consistently used acronym throughout the research literature. As NALM was the one coined by the device’s inventor, it is the one I use throughout this paper. However, other researchers use NILM, NIALM, or NIALMS when discussing these devices. See, e.g. *id.* at 56–57 (NILM); Steven Drenker & Ab Kader, *Nonintrusive Monitoring of Electric Loads*, IEEE Computer Applications in Power 47 (1999) (NIALMS). For the sake of precision, it should be noted here that there are two basic forms of the NALM: the manual set-up NALM (MS-NALM) and the automatic set-up NALM (AS-NALM). The MS-NALMS require manual identification of appliance signatures through appliance monitoring and consumer interviews. See Hart, *supra* note 1 at 1870–72. I focus in this article on the AS-NALM, as its capabilities and development are more relevant to the instant discussion. Thus, the discussion *infra* which purports to explain the capabilities of a NALM is actually only examining the operation of an AS-NALM.

³ Hart, *supra* note 1, at 1871. See also Laughman, *supra* note 2.

⁴ See F. Sultanem, *Using Appliance Signatures for Monitoring Residential Loads at Meter Panel Level*, 6 IEEE TRANSACTIONS ON POWER DELIVERY 1380, 1380 col. 1 (1991). See also, *id.* at 1381 col. 2 (providing illustrative graphs of load signatures for a refrigerator, a washing machine motor, and a fluorescent light). This conclusion, arrived at by researchers nearly a generation ago, rested on an assumption of high-resolution data—an assumption that is not always met in modern energy profile research, but which is becoming increasingly less important for the point’s validity. See discussion *infra*, Part III.B.2.

⁵ Federal Energy Regulatory Commission, *Assessment of Demand Response & Advanced Metering 2008*, Staff Report [hereinafter “FERC 2008 Demand Response Assessment”], at 14, available at www.ferc.gov/legal/staff-reports/12-08-demand-response.pdf. It should be noted that this estimate predated the stimulus package set forward under the Obama Administration that marked some \$11 billion for investment in smart grids.

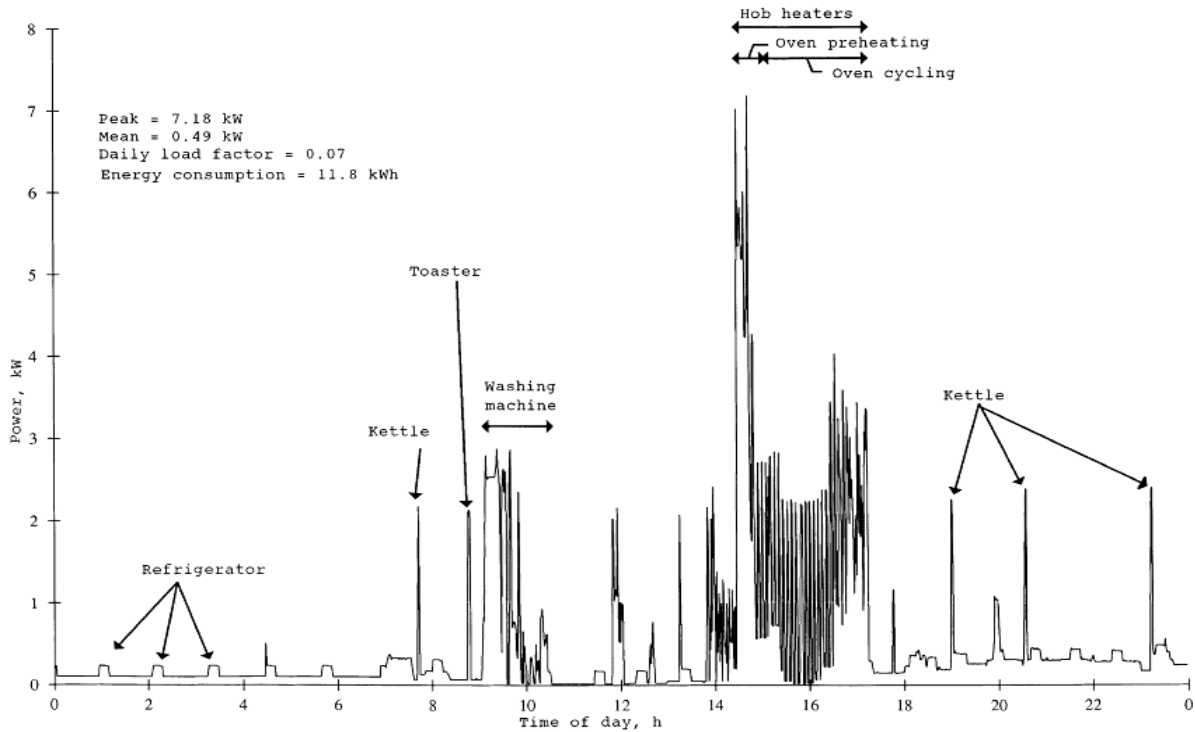

Figure 1: Household Electricity Demand Profile Recorded on a One-minute Time Base⁶

As analytic tools evolve, even information collected at significantly longer intervals—e.g. every fifteen or thirty minutes—can be used to pinpoint the use of most major household appliances.⁷ Such detailed information about the in-home activities of electricity customers can thus be used to piece together a fairly detailed picture of an individual’s daily life or routine. Furthermore, as plug-in hybrid electric vehicles are deployed and customers engage in electricity sales on the grid outside of their homes, an electricity usage profile may become a one-stop-shop for tracking behaviors even outside the walls of the residence. Cataloging and analytic methods advance, and thus the huge volumes of data about electricity usage soon to be unleashed, rather than seen as overly burdensome and expensive to make use of, are likely to be found treasure troves of information.⁸ A more thorough treatment of the technological capabilities and development vectors surrounding smart grid information collection and analysis is set forth in Appendix A.

⁶ G. Wood & M. Newborough, *Dynamic Energy-consumption Indicators for Domestic Appliances: Environment, Behavior, and Design*, 35 ENERGY AND BUILDINGS 821, 822 (2003) (citing M. Newborough & P. Augood, *Demand-side Management Opportunities for the UK Domestic Sector*, IEE Proceedings of Generation Transmission and Distribution 146 (3) (1999) 283–293).

⁷ An Italian study published in 2002 used fifteen-minute interval data—the same resolution collected by most smart meters today—to identify heavy-load appliance uses within an electricity usage profile. Researchers there were able use artificial neural networks to pinpoint the use washing machines, dishwashers, and water heaters with accuracy rates of over 90 percent from within the noise of the aggregated load information. See A. Prudenzi, *A Neuron Nets Based Procedure for Identifying Domestic Appliances Patern-of-Use from Energy Recordings at Meter Panel*, IEEE Power Engineering Society Winter Meeting 941, 942 col. 1, 946 col. 1 (2002).

⁸ See, e.g., Ashlee Vance, *Hadoop, A Free Software Program, Finds Uses Beyond Search*, N.Y. TIMES, Mar. 16, 2009, available at <http://www.nytimes.com/2009/03/17/technology/business-computing/17cloud.html?n=Top/News/Business/Companies/Google%20Inc> (discussing new breakthroughs in software managing internet advertising placement based on search queries and the ways in which these programs are being used in other contexts, such as photo-cataloging, facial-recognition software, and biotech applications). See

B. Information Uses

The information collected by smart meters and other smart grid technologies has many uses. Much of the development and investment surrounding smart grid have focused on those information uses that would best serve electric utilities. Essentially, an electric utility could capitalize on the information to facilitate more efficient network management, peak load reduction, load shaping, and any number of other such uses.⁹ However, a growing industry of “edge services”—services provided to the electric consumer or that are focused on the last mile of electricity distribution—have developed, and with them an impressive new set of uses for smart grid information, ranging from the bill control and demand-side load management to efficiency consulting and energy savings contracting.¹⁰ Additionally, other parties and industries may have good reason to seek out the information for uses not at all connected to electricity provision.

A brief overview of a number of information uses is provided in the table below. This table is intended as illustrative rather than exhaustive.

	Data Use	Description
Utility Services	Outage Detection, Mapping, Restoration	Facilitating every aspect of outage response.
	Theft Detection	Pinpointing unauthorized or unmetered electricity draws.
	Remote Connect/Disconnect	E.g. hook-up new residents w/o a drive-by.
	Asset Management	Monitoring of grid asset use to allow power to be dispatched efficiently and effectively.
	Price Event Notification	Facilitates the implementation of dynamic pricing schemes targeting peak load reduction.
	Power Quality Monitoring	More information allows for better understanding of available resources and better quality control.
	Load Forecasting	Planning and preparing for loads in advance.
Edge Services	Efficiency Analysis & Investment	Pinpointing energy sinks within homes and businesses and directing efficiency strategies and investments such as under an energy performance savings contract (EPSC).

also Positive Energy, *AMI Analytics*, <http://www.positiveenergyusa.com/products/analytics.html> (last visited Mar. 29, 2009) (“Advanced meter data is just around the corner. And it’s a very big deal.”).

⁹ For further discussion of some of these uses, and the number of utilities employing smart grid technologies to these ends, see FERC 2008 Demand Response Assessment, *supra* note 5, at 13–14.

¹⁰ Further discussion of these and other edge service uses is included in Appendix B.

	Data Use	Description
Edge Services <i>cont.</i>	Home Efficiency Monitoring	Monitoring of appliance draw on an ongoing basis and notifying customers when appliances are underperforming.
	Home Load Management through Web Portals and Software	Single-interface access provided to consumers allowing for electric bill and load history review.
	Home Area Network Development	Integrated appliance networks that allow for joint and automated load management.
Other Uses	Insurance Adjustment	Insurance companies could conceivably use the information to develop correlative relationships between, e.g., appliance uses or load profiles and health or driving risks, and set insurance premiums accordingly.
	Marketing & Market Research	Information regarding market penetration and target market usage habits could be valuable to advertisers in numerous ways.
	National Security & Law Enforcement	Officers and investigators could use information about electricity draw to pinpoint possible cite of various nefarious activities such as drug manufacture.

Table 1: Overview of existing and possible smart grid information uses.

C. Electric Utility Information Bundling and Resale

The many things determinable from smart grid information analysis, and the many edge services and other ancillary parties that have a reason to seek it out, suggests that smart grid information has value. This gives rise to the question: could electric utilities turn the new information stream into a source of revenue?

The prevalence of copying technologies makes it difficult to exclude individuals from the use of information goods once they have been disseminated.¹¹ The non-excludable nature of the good raises some immediate concerns for information markets. Absent excludability,

the flow of money through the [information] market will not serve its primary purpose of registering the utility of the commodity being produced. There is no reason to think *ex ante* that the commodities that generate the most attractive

¹¹ See Yannis Bakos & Erik Brynjolfsson, *Bundling Information Goods: Pricing, Profits and Efficiency*, [hereinafter Bakos & Brynjolfsson, *Bundling Information Goods*] Apr. 1998 Draft at 1, available at http://papers.ssrn.com/sol3/papers.cfm?abstract_id=11488 (“Digital copies of information goods are indistinguishable from the originals and can be created and distributed almost costlessly via the emerging information infrastructure.”).

revenue streams paid by advertisers or by ancillary others will be the commodities that ultimate consumers would wish to see produced.¹²

In many ways, this leads to the conflicting policy concerns surrounding market regulation discussed *infra* Part IV. For example, the information market is likely to under-value customer privacy since the individual customers whose information is monetized in such a market are involved in the market in only tangential ways. Of course, excludability can be artificially constructed through disclosure regulations, contracts, or technological protections, but without implementing and enforcing such controls, information goods naturally tend toward public dissemination. Insofar as privacy regulation will establish the boundaries of who can get this information and how they can get it, the formulation of privacy regulations should be seen, not only as consumer protection, but as a form of incentive regulation.

The ultimate question as to whether an electric utility *should* attempt to capture revenues from the flow of smart grid information is left for the determination of others. However, the option is at least viable. Over the last two decades or so, information economic theorists have settled on a dominant strategy for the sale of information goods: product bundling.¹³ Product bundling is the grouping of separate goods together in a single salable package.¹⁴ Bundling is especially appropriate in the context of information goods because of the very low marginal cost of the product.¹⁵ Mixed bundling becomes the strategy of choice when customers value only subsets of an available information resource,¹⁶ or when information customers vary widely in their valuation of bundles: “[W]hen different market segments of [information] customers differ systematically in their valuation of goods, simple bundling will no longer be optimal. However, by offering a *menu* of different bundles aimed at each market segment, a monopolist can generally earn substantially higher profits than would be possible without bundling.”¹⁷ Furthermore, bundling options are easy to identify in the context of smart grid information. The information is susceptible to bundling along a number of different dimensions, depending on the

¹² J. Bradford DeLong & A Michael Froomkin, *Speculative Microeconomics for Tomorrow's Economy*, 5 FIRST MONDAY (Feb. 2000), available at <http://firstmonday.org/htbin/cgiwrap/bin/ojs/index.php/fm/article/view/726/635>.

¹³ See, e.g., Bakos & Brynjolfasson, *Bundling Information Goods*, *supra* note 11, at 1 (“[I]n a variety of circumstances, a multiproduct monopolist will extract substantially higher by offering one or more bundles of information goods than by offering the same goods separately.”).

¹⁴ See *id.*

¹⁵ See HAL R. VARIAN, JOSEPH FARRELL, & CARL SHAPIRO, *THE ECONOMICS OF INFORMATION TECHNOLOGY: AN INTRODUCTION* 19 (Cambridge Univ. Press, 2004) (“[Bundling] is particularly attractive for information goods since the marginal cost of adding an extra good to a bundle is negligible.”)

¹⁶ See ARYYA GANGOPADHYAY, *MANAGING BUSINESS WITH ELECTRONIC COMMERCE* 107 (Idea Group, Inc., 2002) (citing J. C. Chuang & M. Sirbu, *Optimal Bundling Strategy for Digital Information Goods: Network Delivery of Articles and Subscriptions*, 11 INFO. ECON. & POLICY 147 (1999); V. Denicolo, *Compatibility and Bundling with Generalist and Specialist Firms*, 48 J. OF INDUSTRIAL ECON. 177 (2000)).

¹⁷ Bakos & Brynjolfasson, *Bundling Information Goods*, *supra* note 11, Abstract. After an extensive investigation of bundling techniques and competition effects surrounding information products, Yannis Bakos and Erik Brynjolfsson concluded that bundling information goods can have significant advantages for those companies able to engage in the practice. Apropos to this discussion are their conclusions that (1) bundling information goods for sale to down-stream users “makes an incumbent seem ‘tougher’ to competitors and potential entrants,” and (2) “[b]undling can reduce the incentives for competitors to innovate, while it can increase bundlers’ incentives to innovate.” *Id.* at 28. See also VARIAN, FARRELL, & SHAPIRO, *supra* note 15, 19 (Cambridge Univ. Press, 2004) (“There are two distinct economic effects involved [in bundling]: reduced dispersion of willingness to pay, which is a form of price discrimination, and increased barriers to entry.”).

information customer’s desired use of that information. A summary of the various bundling dimensions is set forth in the table below.

<i>Data Bundling Choice</i>		<i>Discussion</i>
Customer	Individual	Information collected from a single smart-meter; electricity profile perfectly corresponds to a single home’s usage. Identifying information (e.g. meter location, resident name) is retained.
	Individual-Anonymized	Raw smart meter information scrubbed of its identifying tags such as resident name, meter location or address, or billing number.
	Aggregated	Smart meter data collected from a number of meters and collated into a single electricity load signal for the purposes of either privacy protection or regional analysis. Aggregation could be done through hardware by integrating these functions into meter functions, or at the software level, by combining the data once it has been collected. Aggregation could be performed at a number of levels, including city blocks, communities, cities, counties, and regions.
Time-Shifting	Real-Time	Provision of electricity usage information in real-time, allowing dynamic response to changing prices or environmental signals, and the ability to identify household activities as they take place.
	Delayed	Provision of usage data delayed from the time of use. Market research and other data-mining uses for smart grid information need not be communicated to the information consumer as quickly as it comes in, but rather could be collected into weekly, monthly, or even yearly blocks and sold in that way.
Resolution	Meter-level Data	Data collected by smart meters for the entire residence or building. The resolution of this data, that is, the interval at which it is collected, could vary depending on the hardware installed for its collection as on the needs of the information customer. Many meters can collect information at as low as one-minute intervals, but identification of some appliances requires only fifteen-minute interval data, and other uses may require even
	Consumer-level Data	Smart meter information is not the only source of information available on a smart grid. Electricity usage preferences, such as those entered in by an electricity customer to automate thermostat response to shifting electricity prices, are themselves data sources. Additionally, smart plug technology could also locate <i>where</i> in the home appliance events occur. Also, as plug-in electric hybrid vehicles gain popularity, and mobile battery-to-grid sales become possible, electricity usage profiles record out-of-home activities.

Table 2: Potential smart grid information bundling choices.

Of course, smart grid information bundling on behalf of electric utilities is not without its costs. First, it would install a bottleneck between those parties engaged in information collection those performing information analytics, two activities between which there are bound to exist economies of scope and scale. Furthermore, there are some concerns that an effective information monopoly in the electric utility would chill innovation and competition in the provision of edge smart grid services such as those described in the previous section. As FERC noted in its 2008 Demand Response Assessment:

[I]ndustry analysts and home automation vendors are concerned about implementing AMI-HAN integration through controllers embedded in the advanced meters. They voice at least two concerns. The concerns include the prudence of allowing the utility, as a regulated franchise, to gain an advantage in an otherwise competitive home automation market, and ‘substantial privacy [and] security . . . issues concerning the embedding of HAN controllers in advanced meters.’¹⁸

These various issues are but flagged here for future consideration. The point for the purposes of this discussion is simply this: the systematic resale—and so disclosure—of individual electricity usage information is a real possibility.¹⁹ This possibility, while potentially having some economic and incentive benefits for the project of electricity provision reform, should be closely monitored if employed in order to protect consumers.

¹⁸ Federal Energy Regulatory Commission, Assessment of Demand Response & Advanced Metering 2008, Staff Report [hereinafter “FERC 2008 Demand Response Assessment”], at 21, *available at* www.ferc.gov/legal/staff-reports/12-08-demand-response.pdf. (citations omitted). The report goes on to note that “[b]road adoption of interoperability standards . . . may lessen concerns that utilities would have an unfair advantage in the home automation market, though the privacy concern might remain.” *Id.* at 21–22.

¹⁹ It should be noted that, though a viable economic model, turning the electric utility into an information hub would be a contentious step, especially for those edge service providers that anticipate getting individual load profiles freely from the individuals themselves. For example, upon its entrance into the smart grid scene with its PowerMeter, Google also took steps to help ensure the business model it had envisioned would be supported by regulation. In particular, the company urged the California Public Utility Commission to require real-time energy usage information be available to smart grid customers rather than only to the electric utility. Comments of Google on Smart Grid Technology Deployment in California, Proceeding R08-12-2009, *available at* <http://www.google.org/powermeter/cpuc.html> (“Google strongly urges the Commission to continue to develop smart grid capabilities in California, and to adopt policies that direct the provision of electricity usage data to consumers in real-time.”).

II. THE PRIVACY CONCERN

Summary

Different uses of smart grid information, and different bundling choices regarding that information's package and sale, implicate different kinds of privacy concerns, ranging from nefarious misuse to inadvertent sharing. Policy responses in favor of privacy protection may differ depending on the specific kinds of privacy invasions targeted for prevention. If the concern is harassment by targeting advertisers, protective regulations should be directed at the information's collection and sale to third parties. If instead the principle concern is the nefarious activities of home invaders, policies should focus on the implementation of technological protections and standards for the information's discard after use. Protecting all privacy concerns surrounding the collection and analysis of smart grid information is likely not to be in the public interest.

Data collection via NALMs has sparked privacy concerns before. In mid-2001, MIT's *Technology Review* ran a story on NALMs, reporting that, "[in] essence, non-intrusive load monitoring is an information technology. And like any such technology, it could gather information that customers would prefer to keep to themselves."²⁰ A researcher reported there that he could use prototypes then monitoring laundry facilities on campus to tell when a student was washing shoes as uneven loads put "uneven strain[s] on a washer's motor" that could be perceived in the collected data.²¹ While the story concluded with a precautionary note on potential privacy implications, the concerns were thoroughly overshadowed by the NALM's limited implementation. Though it was anticipated that NALMs might play a greater role in future development and green building, the article was careful to distinguish the NALM from smart meters, whose relatively low-resolution data paled in comparison to the non-intrusive load-monitoring technology, which was sampling loads several hundred times per second.²²

However, the massive deployment of smart meters across the country and the trend toward finer and finer interval data means that more and more information will be discernable about more and more people. While the raw information about when an appliance event occurred in a given home may not seem to be sensitive information, it could be used to construct a detailed picture of residential life. Tracking appliance events means smart grid information could tell you the answer to questions like

- » How often does a given customer eat microwave dinners as opposed to cooking three-pot meals?
- » How many hours of TV does a resident watch? What kind of TV is it?
- » When does a resident normally shower (and so cue an electricity draw from the water heater)?

²⁰ Alan Leo, *The Measure of Power: Non-Intrusive Load Monitoring Gives Detailed Views of Where Power is Going, With Payoffs for Utilities, Consumers, and maybe Big Brother*, TECH. REV. MAGAZINE (June 28, 2001).

²¹ *Id.*

²² *See id.*

What's more, the raw fact of an individual's monthly level of electricity usage may be becoming a more sensitive issue among some communities as electricity usage is tied ever more to social moors concerning environmental responsibility. This shifting meaning of an individual's energy consumption habits is not without its salient examples: In 2007, the day after Al Gore received an Oscar for Best Documentary in for his production *An Inconvenient Truth*, the Tennessee Center for Policy Research reported that Al Gore's Nashville home consumed significantly more electricity than the national average (to the tune of a 20 fold increase).²³ Roughly a year later, the center reported that the former Vice-President's energy use had increased by ten per cent during the intervening year despite Gore's installation of energy-efficient renovations.²⁴ Drew Johnson, president of the research center, chided, "A man's commitment to his beliefs is best measured by what he does behind the closed doors of his own home. Al Gore is a hypocrite and a fraud when it comes to his commitment to the environment, judging by his home energy consumption."²⁵

The various questions to which smart grid information may unveil answers about individuals thus sparks two concerns: one regarding those that would ask questions for commercial or political benefit, and those that might use the information to target houses for, say burglary. Notice, though, that the two related concerns beg different solutions: the former regulation of the information market, the latter requirements for technological data protections to ensure consumer information is not stolen from otherwise benevolent users.

The smart grid is not all bad news for information privacy, however. The remote metering capabilities of smart meters have actually led some enthusiasts to claim smart grids will be harbingers of *more* privacy: "Because smart meters send information electronically to [the utility] daily, . . . meter readers will no longer have to enter your property."²⁶

A summary of the various kinds of privacy concerns connected with smart grids is provided in the table on the next page. The diversity of privacy concerns leads to difficult policy choices about what kinds of privacy should be protected absolutely, and what other concerns might lose out when balanced against other potential benefits of smart grid deployment.

²³ See Press Release, "Al Gore's Personal Energy Use is His Own 'Inconvenient Truth,'" Tennessee Center for Policy Research, Feb. 26, 2007, http://www.tennesseepolicy.org/main/article.php?article_id=367 (last visited Sept. 3, 2008).

²⁴ See Press Release, "Al Gore's Electricity Consumption Up 10% Despite 'Energy-Efficient' Renovations," Tennessee Center for Policy Research, June 17, 2008, http://tennesseepolicy.org/main/article.php?article_id=764 (last visited Sept. 3, 2008).

²⁵ *Id.*

²⁶ Smart Reader Facts, San Diego Gas & Electric: A Sempra Energy Utility, *available at* http://www.sdge.com/documents/smartmeter/SM-Fact_Sheet-Green.pdf. SDG&E is not the only one excited about the privacy benefits of advanced meters:

Some utilities have worked closely with builders for many years and arranged that essentially all meters are outside and near the front of the property, easily reached by the utility meter reader. But this is not the norm. Meter readers commonly must go around to the back of the house, into the dog's fenced area, behind the foundation planting bushes, and other inconvenient places to read the meter. It's inconvenient for the customer, too. The requirements to keep the dog in on the 14th of the month, or let the meter reader into the basement are all nuisances that customers find increasingly annoying as more of them are working during the day.

Edison Electric Institute, *Deciding on Smart Meters: The Technology Implications of Section 1252 of the Energy Policy Act of 2005*, at 13 (Sept. 2006) (Prepared by Plexus Research, Inc.).





<p>Individuated Patterns</p> 	<p>High-resolution electricity usage profiles can expose individual behavior patterns through the identification of each specific appliance event within the household. Not just when a consumer is at home and when she is away, but further when she cooks dinner, watches TV, takes a shower.</p>
<p>Real-Time Surveillance</p> 	<p>Access to electricity usage in real time adds a further privacy concern to the development of personal behavioral patterns. Not only could models of consumer behavior be developed after examining electricity records, their behavior could be tracked in real time. Also, electric utilities may eventually collect usage information beyond the four walls of the home, e.g., by tracking PHEV charges and battery-to-grid sales.</p>
<p>Information Detritus</p> 	<p>Consumers cast off small pieces of private information in the course of now routine transactions and e-commerce. This information, known as electronic detritus, can, when aggregated, paint a detailed picture of an individual. If conclusions drawn from smart meter data were sold to third parties, it could significantly expand the set of such information. Further, as intuitions regarding the private nature of electricity usage data may be shifting as it is increasingly tied to notions of social responsibility, such detritus may be viewed as particularly sensitive.</p>
<p>Physical Invasion</p> 	<p>Physical invasions come in two types: <i>incidental</i> and <i>targeted</i>.</p> <p>[1] <i>Incidental</i> invasions are those secondary to the purpose of the invader. For example, traditional metering infrastructure required meter readers to go to resident's homes—sometimes even within them—to read monthly consumption for billing. Such “invasions” will be eliminated in a smart-metered world where meter readings are done remotely.</p> <p>[2] More detailed information gathered by smart meters may expose consumers to more <i>targeted</i> and nefarious physical invasions, since it may be possible to glean such information from the meter data as when residents are away from home, and even whether or not they have an electronic security system.</p>

Figure 2: Overview of privacy concerns implicated by various smart meter data services.

III. BALANCING RISKS

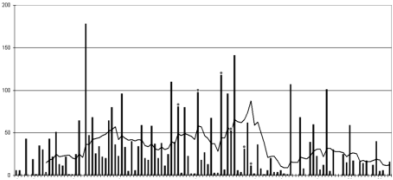
Summary

Smart meters pose regulators with an interconnected set of concerns, at times moving in opposite directions toward contradictory policy goals. The very characteristics that make smart grid information valuable to nascent technology industries, service providers, and environmental efforts also make it potentially damaging to consumer privacy. While consumers should be protected and informed, an overly-restrictive privacy regime could kill still nascent businesses models. Furthermore, determining the value of smart meter information is difficult at this early stage in the industry's development. Giving sole disclosure control over smart-metered information to the smart-metered customer herself may not be the best option for protecting consumer privacy, and may unnecessarily close the door on a potential revenue stream for electric utilities.

This section examines the many policy concerns converging on smart grid development. It outlines a variety of issues including the potential for environmental benefit, the effect on electric utility cost recovery models, and the growth of a market for information concerning

A. *Policies in Tension*

The various concerns bearing down on the development of the smart grid are like a network of interlocking gears: turn one in one direction and it cannot be helped but to turn another in the opposite direction.

The threshold motivation behind smart grid deployment is to enable environmentally sensitive electricity generation, distribution, and consumption practices. "The collection of information about energy consumption from residential and commercial buildings at frequent intervals is a core component of the demand response system."²⁷ Furthermore, information is valuable both in managing demand response efforts and ensuring electricity generation is operating efficiently and effectively.²⁸

Insofar as demand-response can provide electric utilities with peak-load relief, environmental motives operate in parallel with those of electricity utilities. However, traditional rate-of-return regulation creates also incentives in many ways antithetical to the modern project of electricity reform.²⁹ A smart grid is, under the existing regulatory lens, hardly more than a

²⁷ Jack I. Lerner & Deirdre K. Mulligan, *Taking the "Long View" on the Fourth Amendment: Stored Records and the Sanctity of the Home*, 2008 STAN. TECH. L. REV. 3, at ¶ 2, <http://stlr.stanford.edu/pdf/lerner-mulligan-long-view.pdf>.

²⁸ As Amy Abel reported to Congress regarding the deployment of smart meter technology:

It is expected that grid reliability will increase as additional information from the distribution system is available to utility operators. This will allow for better planning and operations during peak demand It is estimated that a 4% peak load reduction could be achieved using Smart Grid technologies.

Amy Abel, CRS Report to Congress: Smart Grid Provisions in H.R. 6, 110th Congress, RL 34288 (Dec. 2007) at CRS-3, available at <http://fas.org/sgp/crs/misc/RL34288.pdf>.

²⁹ See Daniel J. Weiss & Kalen Pruss, *Harvesting Low-Hanging Energy Savings*, Center for American Progress, http://www.americanprogress.org/issues/2009/03/eers_efficiency.html (last visited Mar. 30, 2009) ("[T]he

huge capital expense focused on minimizing profits. If utilities fear that, scaled-up, smart grid deployment will cut into their bottom line, they are likely to drag their feet on such investments, or at least seek assurance that they will be able to recoup the investment through shifting regulatory regimes such as the implementation of decoupling. As Roger Duncan, Deputy General Manager at Austin Energy, noted regarding smart grid deployment: “We haven't figured out the business models . . . [that] work well for the utility and the city government and the citizens Austin Energy has to figure out how to diversify its revenue sources.”³⁰

Environmental Initiatives



High-resolution smart meter data provides detailed usage data to utilities managing electric networks, allowing them to better integrate electricity from renewable resources and distributed production sales, and helps inform consumers of their usage patterns, thereby facilitating demand-side management efforts.

Electric Utility Cost Recovery & Business Models

profits of most utility companies are tied to the amount of electricity sold, not to some other measure of service. Therefore, electricity suppliers have little incentive to reduce their generation because that would reduce profits.”)

³⁰ Martin LaMarca, *Will Anyone Pay for the ‘Smart’ Power Grid?*, CNET NEWS, May 16, 2007, available at http://news.cnet.com/Will-anyone-pay-for-the-smart-power-grid/2100-11392_3-6184046.html (quoting Roger Duncan, Austin Energy).

The smart grid and its environmental benefits are, in many ways, antithetical to traditional electric utility incentives. The use and sale of consumer electricity profiles could play a critical role in transitioning from a model of electricity *sale* to one of electricity *management*.

Edge Service Business Models & Data Markets

The extent to which electric utilities control—and can sell—consumer usage information will have a dramatic effect on markets for that information and emerging business models surrounding its use.

Privacy Implications

The balance struck between the preceding factors will outline consequences for consumer privacy by determining the amount of information collected about consumers, its permissible uses, and its level to which it is control or protected.

Figure 3: Integrated concerns surrounding the implementation of smart metering technology.

One possible option for incenting utilities to roll out smart grid technologies on a large scale, discussed *supra* Part I.C, is to allow them to monetize the information gathered by such technologies, bundling it for resale to edge service providers or other third party interests. But increasing the utility’s control over smart grid information may well turn against nascent edge service business models, chill innovation, or provide new barriers to market entry. Many of the edge services rely on access to high-resolution, real-time information about customer electricity usage. Increasing central utility control over smart grid information may well slow development at the edge of the grid.

By the same token, allowing open access to smart-metered information, while perhaps good for innovation at the edge of the grid, may well endanger consumer privacy. The balance struck between centrally- and consumer-controlled models of smart grid information management will define the nature of the privacy concern. If customers get in the habit of giving out their information early on in the development of the smart grid, it may lead to chronic undervaluing of the commodity.³¹ Repeat-players in the smart grid information space are likely to be careful and considerate with customer information, and subject to market pressures based on privacy-related reputations. However, poor consumer understanding of the information and potential consequences of its disclosure may lead electric customers to be somewhat cavalier with their information, especially in the early stages of smart grid development.

Of course, there are forces other than regulatory decision-making at play in this landscape. Electric utilities may be uninterested or unwilling to play a substantive roll in the analysis and resale of usage data. For example, Xcel Energy has openly expressed its commitment to the philosophy that customer usage information belongs to the customer alone, who can do with it as she sees fit.³² Such an attitude toward the available information is certainly commensurate with the interests of third party energy information management service

³¹ See *supra* note 12, and surrounding discussion.

³² E.g., remarks of Ken Floyd, Vice President, Customer Care and Revenue Cycle, Xcel Energy, keynote speech, University of Colorado Law School, Mar. 30, 2009.

providers, such as Tendril Networks and Google (developing its PowerMeter)³³ as they could then obtain the information necessary for the provision of the service without paying rents to the utility simply to act as an intermediary.

B. *Deciding on the Locus of Disclosure Control*

One way of approaching the varied and sometimes conflicting policy pressures bearing on the smart grid information market is to ask: where should control over smart grid information lie? As a matter of regulatory structure, control over the information collected by smart meters and smart appliances could be placed in one of three places: (1) in the hands of the consumers themselves, (2) in the hands of the utilities, or (3) in the hands of third-party service providers. If central control over the information were given to the utility, it could use the information as it needed to manage the electric network and prepare accurate bills for customers, and could sell or rent that information out to third party interests—with some restrictions to ensure the protection of consumer privacy, of course. If control of the information rested in the hands of third parties, any service provider that tapped into the meter or received information from, say, a consumer's electricity management web-portal could use the information however it saw fit, store it, and sell it to other interested parties. If, on the other hand, the central control over the information resided with the consumer, each use or disclosure of the information would be funneled through the consumer for approval.

It is important to note that these three options are really variations of degree rather than qualitative differences; the consumer would have a threshold choice to opt-in or -out of disclosure. However, the careful tailoring of default-rules and mechanisms, for example, of pre-screening fringe service providers for privacy controls and placing them in opt-in or -out categories as a result of that assessment can shift *effective* control over the information from one party to another (e.g., from the customer to the electric utility).

Placing the control over this information in the hands of the utility that is collecting it makes sense for many reasons:

- [1] *Privacy Protection*: Utility-based information bundling, while a potential bottleneck, provides an opportunity for existing privacy regulations to oversee information disclosure and use.
- [2] *Transaction Costs to Edge Service Providers*: It is likely cheaper for many fringe service providers to go to the electric utility and subscribe to an information stream than to go door-to-door to collect requisite usage information.³⁴
- [3] *Incentive Reform & Environmental Considerations*: Funneling smart grid through the electric utility to edge service providers provides the utility with an opportunity to turn the information flow into a revenue stream, rather than simply using the information to facilitate efficient network management. Such an opportunity could conceivably incent utilities to innovate in information gathering and analysis—precisely the kinds of

³³ Comments of Google on Smart Grid Technology Deployment in California, Proceeding R08-12-2009, available at <http://www.google.org/powermeter/cpuc.html> (“Google strongly urges the Commission to continue to develop smart grid capabilities in California, and to adopt policies that direct the provision of electricity usage data to consumers in real-time.”)

³⁴ Of course, this assumes the edge service is being provided to the end consumer as opposed to, as it often is now, the electric utility itself.

activities that must be focused on if the business model is to transmission from one of electricity sale to one of electricity management.

- [4] *Business & Investment Security*: Unless consumer information is, in one way or another, funneled through the electric utility, the utility cannot use it as a reliable revenue source to leverage a business model shift and potentially relieve customer burdens resulting from carbon legislation.

Of course, sculpting information regulations to effectively locate its control is not without its contentious aspects; there are bound to be winners and losers in the drafting. Upon its entrance into the smart grid scene with its PowerMeter, Google also took steps to help ensure the business model it had envisioned would be supported by regulation.³⁵ In particular, the company urged the California Public Utility Commission to require real-time energy usage information be available to smart grid customers rather than only to the electric utility.³⁶ It can be fairly surmised that Google, a company with impressive direct access to online users, would rather trade a web-portal service for the customer's usage information than pay an electric utility for that information.

The intent here is not to illustrate the incompatibility with the smart grid information trade as governed by the electric utility and the business models being developed by some of the largest players in the smart grid fringe service industry, but rather to point out that there is no vision-neutral option before policy-makers. Inaction on smart grid information control weighs in the favor of some, while tailored regulation would likely weigh in the favor of others.³⁷

While this report leaves the ultimate balancing and analysis of potential costs to others, there is at least some reason to think that an information bundling tactic employed by an electric utility would both economically beneficial and protective of consumer privacy.³⁸

³⁵ See Martin LaMonica, *Google Crashes the Smart-Grid Party*, CNET NEWS, Feb. 10, 2009, <http://news.cnet.com/google-crashes-the-smart-grid-party/> (last visited Mar. 21, 2009).

³⁶ Comments of Google on Smart Grid Technology Deployment in California, Proceeding R08-12-2009, available at <http://www.google.org/powermeter/cpuc.html> ("Google strongly urges the Commission to continue to develop smart grid capabilities in California, and to adopt policies that direct the provision of electricity usage data to consumers in real-time.").

³⁷ Of course, the story of balancing these various policy concerns has a technological side to it as well; technological choices are not policy-neutral.

³⁸ This is not to say, of course, that such a strategy would be without its costs. To the extent this might place a bottleneck between information collection and information analysis—two areas between which there are bound to be economies of scope and scale—such a strategy might cut into natural market efficiencies.

IV. EXISTING PRIVACY LAW: THE RELEVANT LEGAL LANDSCAPE

Summary

The uncertainties surrounding existing privacy protections endanger consumer privacy in the short term while industry practices and consumer privacy intuitions are still being developed. Many existing regulatory structures aimed at protecting similar customer information—including Colorado’s—are either not clearly applicable to the context of smart grid information, or are subject to an exception that may swallow the rule when it comes to protecting consumer privacy. Some useful examples of regulatory responses to information privacy concerns are identified and discussed, notably, provisions promulgated by the Texas Public Utility Commission, aspects of the European Union’s Privacy Directive, and the experiences underlying the Federal Communication Commission’s CPNI Rules.

This section briefly covers Colorado’s and other states’ existing privacy regimes and provides a few case studies for comparison—the European Union’s Privacy Directive and the Federal Communication Commission’s rules governing the customer proprietary network information.

A. Colorado Regulations Concerning Private Information

Colorado prohibits utilities from disclosing “personal information” to other parties.³⁹ Under Colorado’s PUC regulations, personal information can only be disclosed with the signed

³⁹ 4 COLO. CODE. REGS. § 723-1-1104 [hereinafter “CCR § 1104], states:
1104. Personal Information – Disclosure.

- (a) A utility may not disclose a customer’s personal information to any third party, unless the request is either signed by the customer, or is supported by a disclosure form signed by the customer authorizing disclosure to the particular requestor.
- (b) Notwithstanding paragraph (a) of this rule, a utility may disclose personal information in response to warrants, subpoenas duces tecum, court orders, requests from emergency service providers, or as authorized by § 16-15.5-102, C.R.S. A utility may also disclose information regarding a customer’s typical or estimated average monthly gas, steam or electric bill, if such information is requested by a licensed real estate broker or others with similar purchase or sale interests in the customer’s property.
- (c) A utility shall provide any person requesting personal information with a form with which the customer may authorize disclosure. The form shall explain the customer’s rights under this rule. The requestor shall obtain customer authorization for each request, unless the customer has authorized the release of all personal information at any time.
- (d) A utility may disclose personal information requested by a federal, state, or local governmental agency including, but not limited to: the Commission; state and local departments of social services; and federal, state, and local law enforcement agencies. Written requests shall be on official letterhead. In the case of a telephone request, the employee of the regulated entity shall verify the caller’s identity by obtaining the caller’s office telephone number and returning the call, unless the employee knows the caller is an authorized governmental representative. A person requesting information in person shall demonstrate that he or she properly represents a governmental agency.

consent of the affected customer authorizing “disclosure to the particular requestor.”⁴⁰ This protection prevents utilities from requiring the signature of a sweeping consent to disclosure as a condition of connecting to the grid. Each specific request for personal information from the utility must be approved by the customer.

However, the definition of “personal information,” rather than assuaging privacy concerns, confuses the matter. In the first instance “personal information” is defined broadly to mean “any any individually identifiable information obtained by a regulated entity from a customer, from which judgments can be made regarding the customer’s character, habits, avocations, finances, occupation, general reputation, credit, health, or any other personal characteristics.”⁴¹ The interval data on electricity consumption soon to be collected across the country for millions of households may contain information from which judgments and conclusions can be made regarding very specific habits of conduct carried on within the privacy of the home.⁴² Thus it would seem that individual energy profiles that included interval readings would fit nicely within the regulations’ protection of “personal information.”

But the definition does not stop there. In order to clarify its scope, the definition lists specific classes of information are not to be considered “personal” and so subject to the consent disclosure restriction.⁴³ These include, *inter alia*, “information necessary for the billing and collection of amounts owed to a public utility or to a provider of service using the facilities of a public utility.”⁴⁴ In the case of smart meter data, this may well prove an exception that swallows the rule. Specifically, interval data may be used to facilitate price-signaling to electricity customers in order to shift customer behavior and usage patterns through rate structures, such as critical-peak or time-of-use pricing. Indeed, not to enable customer usage shifts in such a way would be to take a pass on one of the principle motivations for deploying smart grid technologies. However, the consequence of such rate structures is to make interval data “necessary for billing” and thus exempt it from the otherwise required privacy protections.

B. Comparative Analysis

The following is a brief discussion of relevant regulatory provisions in other jurisdictions, provided to foster dialogue concerning regulatory options and possible policy responses to the privacy concern presented by the collection of electricity usage information through smart metering.

⁴⁰ CCR § 1104(a), *supra* note 39.

⁴¹ 4 COLO. CODE REGS. § 723-1-1004(t).

⁴² *See id.*

⁴³ *See id.*

⁴⁴ *See id.* The entire list of definitional exclusions in this provision reads as follows:

Personal information does not include: a customer’s telephone number if it is published in a current telephone directory or is scheduled to be published in the next telephone directory; information necessary for the billing and collection of amounts owed to a public utility or to a provider of service using the facilities of a public utility; or Standard Industrial Code information used for purposes of directory publishing.

Id.

i. California

California's Code also suffers from contextual uncertainty and, like Colorado's provisions, leaves somewhat uncertain the level of protection for information collected by smart meters—though more because of its patchwork structure than its substance.⁴⁵ At the outset, California Civil Code provides reasonably good protection of collected consumer information by effectively prohibiting non-anonymized data from being “distributed for commercial purposes, sold, or rented”⁴⁶ and requiring that businesses in possession of personal information about California residents “implement and maintain reasonable security procedures” to protect against inadvertent disclosure.⁴⁷ Furthermore, information no longer being used by the holder is to be destroyed or otherwise modified to “make it unreadable or undecipherable.”⁴⁸ However, the tenor of these protections indicates the real concern of California legislators was targeted advertising,⁴⁹ so it is unclear just how broadly they will stretch in covering the dissemination of smart meter data—especially when there are so many noble causes clamoring for the information.

Under a section of California's Public Utility Code concerned with the implementation of a smart meter pilot program, the code provides: “To ensure customer privacy, unless specifically authorized by the customer, information based upon customer data may not be used for any commercial purpose.”⁵⁰ However, as with Connecticut's provisions, “on the whole, the law [California's Public Utility Code] seems geared towards protecting the investor-owned utilities' data collections, including by not wholly composed of customer information, from adverse market consequences.”⁵¹

Finally, California's treatment of utility-kept information for purposes of law enforcement further muddies the analysis of just how well protected the information is. California Penal Code section 1326.1 allows law enforcement agents to subpoena utility records, but later provides that “nothing in this section shall preclude the holder of the utility records from voluntarily disclosing information or providing records to law enforcement upon request.”⁵²

Researchers at CyberKnowledge and the University of California at Berkeley prepared a report for the California Energy Commission regarding various legal and technical aspects of

⁴⁵ For an excellent overview of the legal framework at issue in California, see P.A. SUBRAHMANYAM, et al., NETWORK SECURITY ARCHITECTURE FOR DEMAND RESPONSE/SENSOR NETWORKS 14 (2005, rev. 2006) (report for the Network Security Architecture for Demand Response/Sensor Networks project, CIEE Award No. DR-04-03A, B, WA No. DR-005, under CEC/CII Prime Contract No. 300-01-043, conducted by CyberKnowledge and the University of California at Berkeley) [hereinafter “CEC DR Security Report”], pp. 20–33, App'x A, available at <http://www.ucop.edu/ciee/dret/d/> (follow “Draft Final Report (pdf)” hyperlink).

⁴⁶ CAL. CIV. CODE § 1798.60. See also CEC DR Security Report, *supra* note 45, at A-1 (stating that “the [California Civil Code] rules may influence the ways in which that [smart meter] data can be disseminated in the market, . . . or may play a role in protecting consumers from the deanonymization of information” and going on to discuss CAL. CIV. CODE §§ 1798.81–1798.82).

⁴⁷ CAL. CIV. CODE § 1798.81.5.

⁴⁸ CAL. CIV. CODE § 1798.81.

⁴⁹ See CAL. CIV. CODE § 1789.82 (obligations cued “if the business knows or reasonably should know that the third parties used the personal information for the third parties' direct marketing purposes”); CEC DR Security Report, *supra* note 45, at A-3 (discussing Cal. Civ. Code §§ 1798.83(a)(1), (e)(6)).

⁵⁰ CAL. PUC CODE § 393(f)(7).

⁵¹ CEC DR Security Report, *supra* note 45, at A-3.

⁵² CAL. PENAL CODE § 1326.1(e).

smart grid network security and information privacy concerns, including a review of California’s pertinent regulations. That report, “Network Security Architecture for Demand Response/Sensor Networks,” can be found online. <http://www.ucop.edu/ciee/dretd/>.

ii. Texas

Texas is the only state currently seeing commercial deployment of smart meters and smart meter-supported services, as opposed to proof of concept operations.⁵³ According to a number of edge service providers, the principle reason is the competition in Texas retail electricity markets. Retail electric providers (REPs) can use edge service provision as a competitive advantage, thereby driving deployments within the market. Further motivating these efforts, the Texas Public Utility Commission will “establish a nonbypassable surcharge for an electric utility to recover reasonable and necessary costs incurred in deploying” advanced meters to electric customers.⁵⁴ However, ensure competitive integrity, an “electric utility shall not provide any advanced metering equipment or service that is deemed a competitive energy service.”⁵⁵

This substantial difference in the electricity landscape has also resulted in a more comprehensive treatment and protection of smart meter data. At the outset, Texas’ privacy regulations did not suffer from overbroad exceptions that might endanger consumer privacy when read in the new context of smart grid technologies and smart meter information.

A retail electric provider is barred from releasing “proprietary customer information . . . to any other person, including an affiliate of the REP, without obtaining the customer’s or applicant’s verifiable authorization.”⁵⁶ While the regulations go on to provide for exceptions, the exceptions are not so broadly cast as to potentially overshadow the protections of the section. The exceptions include, *inter alia*, disclosures to the Public Utility Commission of Texas; to consumer reporting agencies; to local, state, and federal law enforcement agencies; or to the transmission and distribution utility or its agents.⁵⁷ Notably, Section 25.472(b)(1)(B) also allows for a REP to provide customer information to vendors, partners, or affiliates “engaged to perform any services for or functions on behalf of the REP.” However, the regulation keeps consumer privacy in mind even in during such disclosures by imposing a two-fold restriction. First, the

⁵³ Comments to the Colorado PUC of Colorado Public Utilities Commission by Comverge Senior Vice President Tom Van Denver, Apr. 9, 2009.

⁵⁴ TEX PUC Regs. § 25.130(k). Costs must be incurred pursuant to an approved “Deployment Plan.”

⁵⁵ TEX. PUC Regs. § 25.130(d)(12). “Competitive energy service” is defined in TEX. PUC Regs. § 25.343.

⁵⁶ TEX PUC Regs. § 25.472(b). Proprietary customer information is defined by Tex. § 25.272(c)(5) as [a]ny information compiled by an electric utility on a customer in the normal course of providing electric service that makes possible the identification of any individual customer by matching such information with the customer’s name, address, account number, type or classification of service, historical electricity usage, expected patterns of use, types of facilities used in providing service, individual contract terms and conditions, price, current charges, billing records, or any other information that the customer has expressly requested not be disclosed. Information that is redacted or organized in such a way as to make it impossible to identify the customer to whom the information relates does not constitute proprietary customer information.

The Public Utility Commission of Texas makes its relevant regulations available at PUC of Texas, *Substantive Rules – Chapter 25 Applicable to Electric Service Providers*, <http://www.puc.state.tx.us/rules/subrules/electric/index.cfm> (last visited Apr. 15, 2009).

⁵⁷ TEX. PUC Regs. §§ 25.472(b)(A), (C), (E), (F).

third party must agree to be held to the same confidentiality standards as the REP itself. Second, the customer must be given an opportunity to “opt-out” of her information’s disclosure:

- (i) All such agents, vendors, partners, or affiliates of the REP or aggregator shall be required to sign a confidentiality agreement with the REP or aggregator and agree to be held to the same confidentiality standards as the REP or aggregator pursuant to this section; and
- (ii) In the event that a REP shares proprietary customer information with a third party for the purpose of marketing such party’s products or services to the REP’s customer, prior to the release of information to any such agent, partner or affiliate, a REP or aggregator shall provide the customer an opportunity to opt-out of the release of their information for such marketing purposes.⁵⁸

As such, protective requirements are imposed upon those businesses to which the electric utility shares customer information. This is an important component of consumer protection, guarding against the “genie out of the bottle” problem: careful information management on behalf of an electric utility means little if those with whom the utility shares the information are careless or are free to share it with whomever they see fit.

In addition to this background regulation of customer information, the PUC of Texas has adopted specific rules guiding the management of smart meter information.⁵⁹ The regulations specify those parties with presumptive access to the information, provide an avenue for reviewing an organization’s technological information, and reiterate the consumer’s right to control the disclosure of her information to any other parties. The pertinent provisions of this regulation are included here:

Access to meter data.

- (1) An electric utility shall provide a customer, the customer’s REP, and other entities authorized by the customer read-only access to the customer’s advanced meter data, including meter data used to calculate charges for service, historical load data, and any other proprietary customer information. The access shall be convenient and secure, and the data shall be made available no later than the day after it was created.
...
- (3) An electric utility shall use industry standards and methods for providing secure customer and REP access to the meter data. The electric utility shall have an independent security audit of the mechanism for customer and REP access to meter data conducted within one year of initiating such access and promptly report the results to the commission.
- (4) The independent organization, regional transmission organization, or regional reliability entity shall have access to information that is required

⁵⁸ TEX. PUC Regs. §§ 25.472(b)(1)(B)(i), (ii).

⁵⁹ See generally, TEX PUC Regs. § 25.130, available at Sub-chapter F: Metering, <http://www.puc.state.tx.us/rules/subrules/electric/25.130/25.130.pdf>.

for wholesale settlement, load profiling, load research, and reliability purposes.

- (5) A customer may authorize its data to be available to an entity other than its REP.⁶⁰

These provisions, along with the substantive provisions regulating electric service providers discussed earlier, constitute the most thorough regulatory treatment of the smart grid privacy problem to date.

iii. Connecticut

Connecticut’s regulations provide a good example of simple information control that may adequately protect privacy, but may nonetheless be ill-adapted for the smart grid context. Connecticut’s Department of Public Utility Control defines protected “customer information” as

customer-specific information which the electric distribution company or its predecessor electric company acquired or developed in the course of providing electric distribution services and includes, but is not limited to, *information that relates to the quantity, time of use, type and destination of electric service, information contained in electric service bills* and other data specific to an electric distribution company customer.⁶¹

Connecticut utilities can only freely disclose such “customer information,” including information required for billing and load reporting, to their generation entities or affiliates.⁶² All other disclosures require the utility to “receive prior affirmative written customer consent.”⁶³

These provisions answer the potential problem posed by Colorado’s regulatory landscape—namely, whether information used to determine a customer’s electric bill is considered protected—however the breadth of the provision may well hamper edge service providers. Additionally, while these provisions appear well suited to handle the potential privacy problems surrounding the collection of usage data by smart meters, the language seems to have been drafted with an eye to regulating the disclosure and sale of customer lists in competitive electricity markets. The disparate focus when applied to this context—a protection for utility secrets used for the protection of consumer private information—leaves a big question mark about how the provisions would be implemented if disclosure practices were challenged under them.

iv. European Union

In 1995, the countries of the EU adopted the European Union Data Protection Directive (“the Directive”), a common set of rules setting out data safeguards and standards of care.⁶⁴ The

⁶⁰ TEX PUC Regs. § 25.130(j)

⁶¹ CONN. DPUC Regs § 160224h-1(2) (emphasis added).

⁶² CONN. DPUC Regs § 16-224h-4(a)(1). There are, however, some requirements placed on this disclosure process. See CONN. DPUC Regs § 16-224h-4(a)(3).

⁶³ CONN. DPUC Regs § 16-224h-4(a)(2).

goal of protection outlined in the Directive is binding on EU countries, but the language itself is not. Each country is tasked with developing its own implementing legislation, it must be consistent with the standards set forth in the Directive.⁶⁵ However, examining the Directive's provisions offers some insight into how smart meter data may be considered and protected in Europe.

At the outset, Article 2(a) of the Directive defines "personal data" as "any information relating to an identified or identifiable natural person ("data subject"); an identifiable person is one who can be identified, directly or indirectly, in particular by reference to an identification number or to one or more factors specific to his physical, physiological, mental, economic, cultural or social identity."⁶⁶

Categorization as "personal data" triggers several rights and obligations under the Directive. Article 6(1) requires that personal data (a) be "processed fairly and lawfully,"⁶⁷ (b) be "collected for a specified" purposes and not be further processed for other purposes,⁶⁸ (c) be merely adequate and not excessive for the purposes motivating its collection,⁶⁹ (d) be kept accurate,⁷⁰ and (e) be kept in a form allowing for identification for no longer than necessary.⁷¹ Subsection (b) addresses concerns surrounding the systematic disclosure or sale of collected information: restrictions on further processing or use for other than the original purpose cut out the potential consumers of private information like insurance companies and targeted advertising firms. Subsection (c) and (e) take steps toward protecting electricity consumers against inadvertent disclosure of the information to parties that may nefarious intentions: information that contains no more detail than necessary and that must be scrubbed of its identifying information as soon as that information is no longer needed helps curb risks associated with the leak of such information.⁷²

Thus, as with Colorado's PUC provisions,⁷³ the threshold definitions and general protections seem to provide ample room to protect the smart-metered electricity customer. While they do not offer perfect protection out of the box, they at least provide the skeletal structure to protect electricity consumers from privacy invasion. If combined with a system for aggregating and anonymizing the information, it seems that the Directive's provisions could be sufficient to guard against many of the privacy concerns raised by smart meters.

However, also like Colorado's provisions, the Directive provides exceptions that may cover smart meter data:

Article 13 – Exemptions and restrictions

⁶⁴ See DANIEL J. SOLOVE, MARC ROTENBERG, & PAUL M. SCHWARTZ, INFORMATION PRIVACY 900 (2006) (discussing the European Union Data Protection Directive of 1995, Directive 95/46/EC, [hereinafter "EU Data Directive"] available at http://ec.europa.eu/justice_home/fsj/privacy/law/index_en.htm (follow "HTML version" or PDF version" hyperlink)).

⁶⁵ See *id.* at 901.

⁶⁶ EU Data Directive, *supra* note 64, art. 2(a).

⁶⁷ *Id.* art. 6(1)(a).

⁶⁸ *Id.* art. 6(1)(b).

⁶⁹ *Id.* art. 6(1)(c).

⁷⁰ *Id.* art. 6(1)(d).

⁷¹ *Id.* art. 6(1)(e).

⁷² Incidentally, the recommendations made to the California Energy Commission on the issue of privacy and security in demand response programs mirrors the principles in the EU Directive set forth here. See CEC DR Security Report, *supra* note 45, at 76–77.

⁷³ See *supra* Part IV.A.

1. Member States may . . . restrict the scope of [requisite privacy protections] when such a restriction constitutes a necessary measure to safeguard:
 - (a) national security;
 - (b) defence [sic];
 - (c) public security;
 - (d) the prevention, investigation, detection and prosecution of criminal offences, or of breaches of ethics for regulated professions;
 - (e) an important economic or financial interest of a Member State or of the European Union, including monetary, budgetary and taxation matters;
 - (f) a monitoring, inspection or regulatory function connected, even occasionally, with the exercise of official authority in cases referred to in (c), (d) and (e);
 - (g) the protection of the data subject or of the rights and freedoms of others.⁷⁴

Electricity consumption information is already used to investigate marijuana growth and drug manufacture.⁷⁵ As the resolution of electricity consumption information increases, it will only become more useful for such enforcement activities. While it turns on an interpretation of the term “occasionally,” there at least is a good argument that such usage data fits within Article 13(f) of the directive as at least occasionally connected with defense, public security, or criminal investigations.

If such an argument is successful, any protections afforded electricity consumers by Article 6(1)(c) and (e) could potentially evaporate. Interests concerned with security and criminal investigations would most certainly argue they need to be able to examine historical usage records and further that highly detailed information can only lead to more accurate and efficient law enforcement. Thus those data management obligations under Article 6(c) and (e) could fall away.

The protections of 6(1)(b) fare something better, though may still be eroded somewhat (reasonably) in the name of law enforcement and defense. Where the data management obligations evaporate entirely if those management practices even sometimes stymie law enforcement efforts, disclosure restrictions that stymie law enforcement need only adjusted on a case-by-case basis in order to facilitate the information need.⁷⁶

C. Federal Privacy Law

⁷⁴ EU Data Directive, *supra* note 64, art. 13(1) (emphasis added).

⁷⁵ *See, e.g., Kyllo*, 533 U.S. 27 (2001).

⁷⁶ Another possible categorization of electricity usage data is possible—though somewhat less likely—under the EU Data Directive, which would cue different data management responsibilities make applicable a different exception. Specifically, usage data is arguably not “obtained from the data subject,” EU Data Directive, *supra* note 64, art. 11(1), as the equipment for its measurement and recording are provided and maintained by the utility, and the information collected is not so much asked for but obtained through a kind of surveillance. While it could be argued that the customer’s opting-in to electric services makes the collection voluntary, it is fair to query just how voluntary electric service is in the increasingly technologized world. Even if covered thusly, however, it appears Article 11’s own exception would apply, as analysis could easily be construed as “processing for statistical purposes or for the purposes of historical or scientific research,” thereby eroding the protections of section 11(1). *Id.* art. 11(2).

The principle source of privacy regulation for electricity data lies with state regulatory bodies such as Public Utility Commissions. However, federal does affect the relevant legal landscape in a few important ways, and can inform a state agency's decisions in still others. The following sections briefly discuss the pertinent privacy analogy of the Federal Communication Commission's consumer private network information regulations, as well as how the Fourth Amendment may bear on the handling of smart grid information.

ii. The Federal Communications Commission's CPNI Rules

Section 222 of the Communications Act of 1934 establishes a duty of every telecommunications carrier to "protect the confidentiality of proprietary information."⁷⁷ It then goes on to establish a framework for the protection of such customer proprietary network information (CPNI).⁷⁸ The Federal Communications Commission has since fleshed out this framework through what are known as the CPNI Rules.⁷⁹ While not bearing directly on the context of a smart grid information network, the CPNI Rules provide a good analogy for consideration.⁸⁰ A host of recent advocacy,⁸¹ regulatory,⁸² and enforcement efforts⁸³ to update the CPNI Rules due to privacy concerns similar to those arising in the smart grid context. As such, the CPNI rules case study can provide a foundation for thinking through privacy regulation surrounding smart grid information.

The statutory and regulatory protections extended to CPNI is framed by a strong policy to encourage the provision of new technologies and services to network customers.⁸⁴ This is backed by a requirement that public-interest inquiries and challenges brought regarding new

⁷⁷ 47 U.S.C. § 222(a).

⁷⁸ See generally 47 U.S.C. § 222.

⁷⁹ 47 C.F.R. §§ 64.2001–64.2011.

⁸⁰ As long as smart grid information management and trade remain ancillary to the purpose of electricity provision for an electric utility, such networks are likely to be viewed as private networks facilitating the utility's operations. However, were the business models of electric utilities to undergo a paradigm shift toward one of information management (say, even electricity network switch became decentralized and the principle purpose of the electric utility was to facilitate information transfer and so efficient management), there is at least a colorable argument that such activities would fall under the Federal Communication Commission's Title I—or even Title II—authority under the Communications Act of 1934 to regulate the collection and disclosure of personal information related to information or telecommunication services, and even be *subject to* the CPNI rules themselves. See 47 U.S.C. §§ 153 (defining "telecommunications service and other relevant terms in determining jurisdictional scope), 222 (setting out guidelines and definitions for the protection of customer proprietary network information (CPNI)); *Nat'l Cable & Telecom. Ass'n. v. Brand X Internet Services*, 545 U.S. 967, 996–999 (2005) (interpreting "telecommunications" as defined in the Communications Act of 1934 and focusing on the "transparency" or unprocessed nature of the information transmission). At the moment, though, such a shift seems little more than a thought experiment.

⁸¹ See Electronic Privacy Information Center, *CPNI*, <http://epic.org/privacy/cpni/> (last visited Apr. 11, 2009) (outlining EPIC's advocacy on behalf of telecommunications consumers in driving the recent review of the CPNI rules).

⁸² See Federal Communications Commission, In the Matter of Implementation of the Telecommunications Act of 1996: Telecommunications Carriers' Use of Customer Proprietary Network Information and Other Customer Information, Order FCC 07-22, Apr. 2, 2007, available at http://hraunfoss.fcc.gov/edocs_public/attachmatch/FCC-07-22A1.pdf.

⁸³ See, e.g., Press Release, Federal Communications Commission, Statement of FCC Acting Chairman Michael J. Copps on Enforcement Bureau Actions Regarding Protection of Consumer Privacy, Feb. 09, 2009, available at http://hraunfoss.fcc.gov/edocs_public/attachmatch/DOC-288810A1.pdf.

⁸⁴ See 47 U.S.C. § 157(a).

technologies are required to be completed and ruled upon within twelve months, thereby allowing keeping the regulatory process from overly burdening the introduction of new services.⁸⁵ The term “customer proprietary network information” is defined by the statute to mean:

- (A) information that relates to the quantity, technical configuration, type, destination, location, and amount of use of a telecommunications service subscribed to by any customer of a telecommunications carrier, and that is made available to the carrier by the customer solely by virtue of the carrier-customer relationship; and
- (B) information contained in the bills pertaining to telephone exchange service or telephone toll service received by a customer of a carrier.⁸⁶

CPNI does not include subscriber list information. After recent review, the FCC revised their CPNI regulations such that now, subject to a few, specified exceptions, “a telecommunications carrier may only use, disclose, or permit access to its customer’s individually identifiable CPNI subject to opt-in approval.”⁸⁷

The FCC’s comments regarding the shift from an opt-out to an opt-in regime are instructive. Specifically, the FCC found there to be “a substantial need to limit the sharing of CPNI . . . to protect a customer’s privacy” due to a growing black market for the information and “concrete evidence that the dissemination of this private information does inflict specific and significant harm on individuals.”⁸⁸ Furthermore, the FCC noted that “once the CPNI is shared with a joint venture partner or independent contractor, the carrier no longer has control over it and thus the potential for loss of this data is heightened.”⁸⁹ Thus the FCC found that “sharing of data [with joint venture partners and independent contractors], while still permitted, warrant[ed] a requirement of express prior customer authorization.”⁹⁰

The FCC went on in the decision to respond to complaints that merely imposing an opt-in requirement would not be enough to adequately protect privacy: “[W]e find that an opt-in regime will clarify carriers’ information sharing practices because it will force carriers to provide clear and comprehensible notices to their customers in order to gain their express authorization to engage in such activity.”⁹¹ However, the FCC’s optimism in this respect is presented without justification. The assumption that a clear discussion of (lacking) data protections will be required in order for a carrier to obtain customer consent is unfounded. Descriptions of risks may remain vague and couched in language that trumpets the benefits of allowing information disclosure. Additionally, there is an apparent presumption is that, once customers are informed, the market will serve to influence the behavior of companies handling CPNI. However, it is far from clear how companies might be induced to handle the information with care—even in the faced with security breaches—if customers have already consented to those risks.

⁸⁵ See 47 U.S.C. § 157(b).

⁸⁶ 47 U.S.C. § 222(h)(1).

⁸⁷ 47 C.F.R. § 64.22007; 67 Fed. Reg. 59212, Sept. 20, 2002, as amended at 72 Fed. Reg. 31962, June 8, 2007.

⁸⁸ See Order FCC 07-22, *supra* note 82, ¶ 39 (citations omitted).

⁸⁹ *Id.*

⁹⁰ *Id.*

⁹¹ *Id.* ¶ 41.

ii. Fourth Amendment Jurisprudence

Other authors—most notably Jack Lerner and Deirdre Mulligan—have dealt squarely with Fourth Amendment concerns related to advanced metering infrastructure and high-resolution energy usage information.⁹² The lessons of their investigation should, however, be kept in mind—namely, that interval data of electricity consumption appears to be in something of a no-man’s-land under Supreme Court Fourth Amendment jurisprudence. On the one hand, the Court has upheld the sanctity of the home as the touchstone for privacy protection.⁹³ Technology that effectively pierces the blinds, exposing information about activities inside the home requires a warrant before it is employed. It would appear that electricity usage data, as it contains many intimate details about the in-home activities of consumers, allows investigators to see through walls into the home and so access to the information should be restricted to essentially a need-to-know basis.⁹⁴

On the other hand, business records collected and kept by third parties enjoy far fewer privacy protections, the underlying theory being that consumers elected to transact with the business, and to engage in activities open to observation by the public.⁹⁵ Traditional electricity metering information has generally been treated as business records and so lies unprotected by the Fourth Amendment.⁹⁶ Though Lerner and Mulligan seem optimistic that courts will “take the long view” on Fourth Amendment protections and extend them to smart metering data, my own analysis is that the law as it stands does not decide the matter, and the jurisprudence could easily be used to justify either result.

⁹² The instant discussion is meant merely to bring out some of the issues and not provide a comprehensive treatment of these concerns. For a more comprehensive treatment, see Jack I. Lerner & Deirdre K. Mulligan, *Taking the “Long View” on the Fourth Amendment: Stored Records and the Sanctity of the Home*, 2008 STAN. TECH. L. REV. ¶¶ 7–8, 11–30, available at <http://stlr.stanford.edu/pdf/lerner-mulligan-long-view.pdf>.

⁹³ See *id.* ¶¶ 14, 18 (discussing *Kyllo v. United States*, 533 U.S. 27, 37-40 (2001), a case in which the Supreme Court ruled law enforcement’s use of thermal imaging without a warrant to spot areas of relative heat within a residence, areas later discovered to be used for growing marijuana).

⁹⁴ “In the home, our cases show, all details are intimate details, because the entire area is held safe from prying government eyes.” *Kyllo*, 533 U.S. at 27. It should be noted, though, that the court’s reasoning in *Kyllo* relied at least in part on the fact that thermal-imaging technology was not readily available and thus the law enforcement officer’s techniques seemed even further from “naked-eye surveillance.” *Id.* at 34-40. In the context of smart meter technology, the massive deployment efforts discussed in Part I.A would almost certainly render the technology “readily available,” which may cut against Fourth Amendment protections. More likely, though, the focus would come down on the information-extracting algorithms that allow users to glean the details of appliance activities from the smart meter data. Those are likely to be less common and less available than the meters themselves, which may make the analogy stronger and so bolster the argument for Fourth Amendment protection.

⁹⁵ See Lerner & Mulligan, *supra* note 92 ¶¶ 19–22 (discussing *Smith v. Maryland* 442 U.S. 735 (1979); *United States v. Miller*, 425 U.S. 435 (1976); *Couch v. United States*, 409 U.S. 322 (1973)).

⁹⁶ *Id.* ¶¶ 25–30.

V. POLICY RESPONSES

Summary

Designing a policy response to the privacy concerns raised by smart grid information collection and aggregation involves three aspects: (1) disclosure consent regulations, (2) restrictions imposed on third parties such as joint venture partners or independent contractors that may hold sensitive information, and (3) requirements that customers be notified in the event their usage information is obtained by anyone beyond the limits of their consent. Opt-in and opt-out regimes for controlling disclosure provide regulators with flexibility to strike the right balance among competing policy concerns.

The questions of a policy solution is particularly difficult in the context of smart grid development, as the privacy concern and policy response have a kind of tail-chasing character: A proposed data service or data collection spurs specific privacy concerns based on the data resolution and surrounding technological storage and transmission protections. That privacy concern in turn drives a balancing of risks and public policies: consumers want privacy, but is absolute privacy worth putting off the deployment of important environmental and energy security infrastructure? The result of that balancing underlies a policy response. However, policies that set limitations on the collection or dissemination of potentially private information by either restricting the resale of data or inhibiting access to collection at the meter (say, if meter access was restricted technologically to ensure only the utility could get the sensitive information) in effect determine the scope of possible data services. The process is thus back where it started. All of this, of course, takes place within the context of existing privacy jurisprudence and positive law, which itself may shift with the new technological pressures.

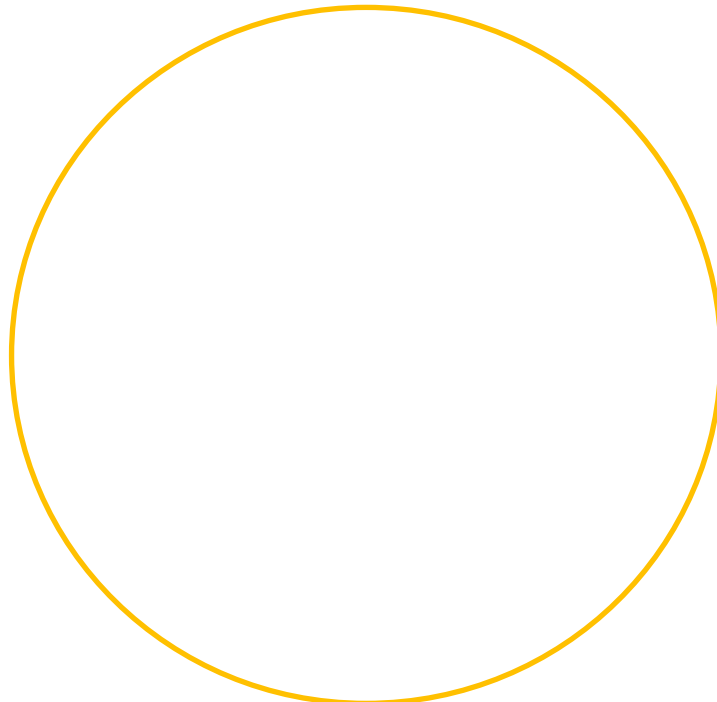

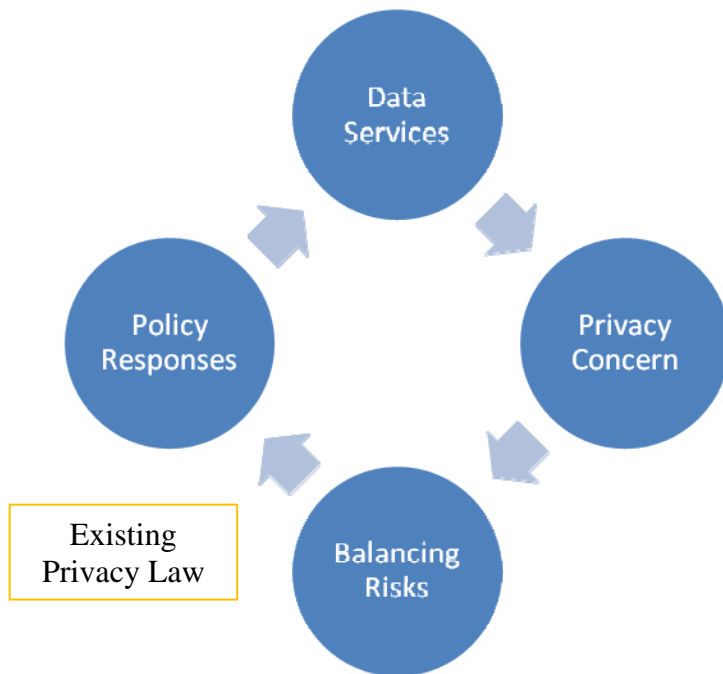

The following sections various aspects of affirmative policy-response options before state regulatory bodies. The regulatory approaches are divided into three categories, each providing a different kind of consumer protection. The first category is disclosure consent requirements, which are essentially variations on opt-in and opt-out regimes. Opt-in regimes provide customers with a choice to allow their names to be placed on the list of those who are willing to share their usage information. Conversely, opt-out regimes place people’s name on the list as a default, and then provide them with an opportunity to remove their names from the list. These two simple tools can be used in a variety of ways to craft consumer interactions with data-sharing. The second and third categories of regulatory response is information protection requirements, essentially guidelines for the data management, and consumer notice requirements, under which customers would be notified in the event their personal information was obtained by parties to whom they had not consented have access to it.

Policy Type		Description
Disclosure Consent Requirements	Opt-In & Opt-Out Regimes	Electricity customers opt-into or -out of certain information disclosure permissions, thereby allowing utilities to share information with categories of information customers.
	Privacy Tariff / Dividend	Electricity customers pay a premium for service if they opt to restrict access to their usage information, or receive a dividend for allowing the utility to share it with those parties it sees fit.
Protection Requirements (Procedural & Technological)		Imposition of technological and procedural requirements on information customers, thereby ensuring only those parties able to protect the information have access to it.

Security Breach Notice Requirements	Requirements that holders of smart grid information inform consumers in the event information is stolen or otherwise accessed by unauthorized individuals.
--	--

Table 3: Menu of policy tools for protecting consumer privacy.

A. Disclosure Consent Requirements

The first step in protecting consumer privacy with regard to smart grid information lies in determining which parties can access the information. The two methods for regulating disclosure more or less parallel the two options that face regulators: decide which parties should enjoy access to customer information or leave that decision to those companies engaged in electricity provision and management such as the electric utilities themselves.

i. Opt-In / Opt-Out Regimes

For Colorado and states with similar regulatory protections, the simplest solution would be to simply clarify that smart-meter data and appliance event information does in fact fall within the scope of protected “private information” that requires a case-specific disclosure consent from the affected customer.

While this option would effectively ensure that the exception does not swallow the rule when it comes to disclosure protections, it is likely too burdensome from the perspective of a shifting electricity management industry. For each new service partner in the development of a smart grid, utilities would have to retrieve new consents from each customer on the grid.

Likely more appropriate though more ambitious, the Commission could construct a tiered program where consumers opted-in to some categories of services and opted-out of others. An example of such a tiered structure might be:

- [1] One-time, umbrella opt-out defaults for an electric utility to share information with electricity service partners and companies closely-related to electricity provision. A customer’s opt-out might well trigger a rate response, insofar as it might mean real-time pricing could not be implemented with respect to that customer.
- [2] A one-time, umbrella opt-in requirement for information disclosure to energy consultants, efficiency monitoring service providers, or appliance and home-automation vendors.⁹⁷
- [3] Case-specific opt-in requirements for disclosure to entities unrelated to electricity provision or management such as data brokers or insurance providers.

By carefully setting defaults, regulatory control of the information could both extend some flexibility to an industry in flux while still protecting consumers against disclosures to sectors wholly unrelated to the context of the information’s collection.

Critics of such an approach are likely to point to the difficulty of structuring tiers for opt-in and -out defaults before the market fully matures. Furthermore, there is some danger that an overly restrictive privacy regime could chill both innovation and market entry in a rapidly

⁹⁷ For an example of such an umbrella option, see TEX PUC REG. § 25.472(b)(1)(B)(ii)(II) (allowing for an electric customer to make a choice to be included in all future marketing efforts of her REP affiliates).

moving industry. The smart grid insight, fundamentally, is the use of information in an otherwise blind system of electricity provision. Any constraint on the flow and analysis of that information is likely to be seen as detrimental market participants. However, in developing such a policy option, the FCC's lesson in the telecommunications context should be kept in mind: opt-in requirements for disclosure are the more protective and necessary in the context of sensitive information.⁹⁸

ii. Privacy Tariff or Dividend

Another possible method for protecting consumer privacy on the front end is through the imposition of a "privacy tariff" or information sharing dividend. Such an approach would take advantage of the data bundling business model smart grid information provides electric utilities.⁹⁹ Under the tariff model, electricity customers would be charged a premium if they chose to restrict the electric utilities ability to share their usage data. Alternatively, customers could be provided with a dividend funded through the utility's resale of that information. These options could be viewed as but extreme versions of umbrella options—a single choice determines both a customer's level of information protection and her electricity rate structure.

The principle benefit of the privacy tariff or dividend is the expansive flexibility it gives to smart an electric utility to develop the information market and seek service development as it sees fit with very little obstruction. This early in the deployment of smart grid technologies, many utilities don't know just who they need to give the information to in order to extract the most benefit from the effort. These models give electric utilities some room to experiment while they design their information systems. Additionally, advocates of such an approach would finger the electric utilities' risk aversion as a form of reassurance during this transition process: electric utilities are not likely to take very big risks with consumer data. Furthermore, these models sidestep the difficulty with more tailored opt-in or -out regimes of divining market structure and industry categories prior to the market's maturity.

However, the privacy tariff method does little to drive customer education of privacy risks and so participation. Furthermore, it represents a philosophical twist in both privacy protection and utility regulation: customers would be essentially charged for maintaining their privacy.

B. *Information Protection Requirements*

In order to provide comprehensive privacy protection, restrictions on information use and sale must reach beyond a regulated electric utility alone. The threshold consent requirements for disclosure of usage information to third parties would then have to be buttressed by constraints imposed on those third parties. Here, the restrictions would likely have to be imposed via contract, to ensure that non-utility companies handling sensitive consumer data could not sell that data to information customers where those customers had declined to allow the utility to do exactly that.

There are four aspects to a comprehensive suite of information protection requirements. These aspects are summarized in the table here, and discussed in greater detail below.

⁹⁸ See discussion *supra*, notes **Error! Bookmark not defined.**–**Error! Bookmark not defined.** and accompanying text.

⁹⁹ Described *supra* Part I.C.

Control Type	Description	Example
<i>Confidentiality Agreement</i>	Information holder agrees to be subject to the rules and regulations governing the information's control, e.g., and rules promulgated by a Public Utility Commission for consumer protection.	Contract provisions required by a Utility Commission as a prerequisite to a Utilities sale of smart grid information to 3 rd parties
<i>Procedural Best Practices</i>	Procedures implemented by information holders to protect against information misuse.	European Union Data Protection Directive, Article 6(1)
<i>Technological Protections</i>	Technical measures such as data encryption and firewalls that protect data banks against theft or data breach. As technical protections are ever-changing, regulations must either be continually update or impose dynamic requirements.	Texas Code § 25.130(j)(3) (referencing "industry standards" for data security") Clean Air Act technology forcing standards (CAA §§ 165(a)(4), 111(a)(1), 172(c)(1))
<i>Audits/Self-Assessments</i>	Information holders would be subject to evaluations of their technical and procedural protections.	Texas Code § 25.130(j)(3)

Table 4: The various facets of information protection requirements.

First and foremost, parties obtaining smart grid information from an electric utility would have to agree to abide by the jurisdictions disclosure consent regulations. Without such a confidentiality agreement, the information could easily become a genie that cannot be stuffed back into the bottle. Such an agreement upon obtaining the information allows for later causes of action if that party is negligent in protecting the information or discloses the information to entities without the consent of the electricity customer.

Along with the confidentiality agreement, overseeing Commissions should direct smart grid information holders to implement a set of procedural best practices to guard against the information's misuse. An example of such a suite of requirements can be drawn from the EU Data Directive:¹⁰⁰

Smart Grid information must be:

- [1] processed fairly and lawfully,
- [2] sought or collected for specified purposes, and analyzed only for those purposes,
- [3] merely adequate and not excessive for the purposes motivating its collection,¹⁰¹
- [4] kept accurate, and

¹⁰⁰ See *supra* notes 66–71 and accompanying text.

¹⁰¹ Such a requirement would likely mean electric utilities could only collect information at intervals that are necessary for the provision of certain services or the calculation of a customer's bill under a dynamic rate structure.

[5] kept in a form allowing for identification for no longer than necessary.

Such a set of protections does the heavy lifting when it comes to securing against privacy invasion. Because it is those qualities of smart grid information that make it valuable that also make it dangerous to consumer privacy, carefully directing how the information is used and why the information is gathered is central to a regulatory regime that effectively protects consumers without needlessly hindering development and innovation.

In addition to these procedural requirements that seek to minimize invasive uses of the information, the data should be guarded with technological protections, such as encrypted transmission and firewalled database storage, to ensure the information does not fall into the wrong hands. However, as technological protections are ever-changing in the arms race for data security, regulations need either to be continually updated, or flexible enough to impose determinable standards in the face of changing technology. Texas regulations answer this dilemma by requiring electric utilities implement “industry standards and methods” for secure access to meter data.¹⁰² Another approach can be gleaned from the Clean Air Act, which requires various emitters meet varying levels to technological sophistication in their emissions control technologies. Similarly, information holders might be required to meet standards described for “best available control technologies,” “reasonably available control technologies,” or best demonstrated control technologies—the difference lying in the availability and cost of the various technological controls.¹⁰³

Finally, the security efforts—technological and procedural—undertaken by smart grid information holders to protect consumer privacy should be assessed, either through independent security audits or self-assessment reports. Depending on how centralized an information trade is desired, third parties might also either be prohibited from disclosing the information to others outright, or simply required to receive the same customer authorization that would be demanded of the electric utility under the same circumstance. In addition to such restrictions, toothsome liquidated damages clauses included in data sharing contracts could both protect against breaches as well as provide the electric utility with an incentive to “police” the data market for disclosures that endanger consumer privacy or are otherwise against the public interest.

C. Notice Requirements

Another important aspect of privacy regulation is requiring notice to a customer in the event her information is stolen from or lost by a company entrusted with its care. The sensitivity of the usage information warrants keeping customers in the loop, not just at the decision point of opting in or out of various sharing schemes or pricing mechanisms, but also as the information is handled in the normal course of business.¹⁰⁴

¹⁰² TEX PUC Regs. § 25.130(j)(3).

¹⁰³ CAA §§ 165(a)(4), 111(a)(1), 172(c)(1).

¹⁰⁴ This lesson was learned in spades in the context of data brokers such as ChoicePoint. Data brokers came under fire for misuse or inadequate protection of customer information in late 2004 and 2005. The data brokers grew up collecting electronic detritus and buying up databases, exploiting existing information in ways that were not envisioned by the customers at the time of their disclosures, or even many of the aggregators. The privacy backlash was a response to the “loophole” business model style that seemed to prey on naïveté, and ultimately turned the critical eye of the federal government on the business. See CRS Report RS22137, *Data Brokers: Overview and Industry Background*, at 2–3; ChoicePoint Annual Report (Form 10-K), at 9 (filed Feb. 2008), available at <http://sec.gov/Archives/edgar/data/1040596/000119312508043135/d10k.htm> (describing the Federal Trade Commission’s resultant Stipulated Final Judgment and Order for Civil Penalties).

In the wake of a scandal surrounding the security breach of a prominent data brokerage firm ChoicePoint in 2005, most states enacted laws requiring such notice.¹⁰⁵ For the most part, these regulations are modeled after California’s Notice of Security Breach law.¹⁰⁶ However, many of these regulatory regimes—Colorado’s among them—rely on the definition of “personal information” (or some form of the phrase) to define their scope.¹⁰⁷ In fact, in Colorado’s case, the applicable definition of “personal information” is even more restricted in the context of notices of security breaches than in others: it contemplates only information in which a resident’s name is connected to her social security or driver’s license number, or to an account or credit card number.¹⁰⁸ As smart grid information falls beyond the reach of this and similar definitions in other states, consumers have cause for concern.

In addition to the notice requirements, companies whose security is breached may be afforded safe harbor so long as the security audits/self-assessments discussed in the previous section are up-to-date and adequate, and their measures are assessed to have been sufficient under whatever technological requirements may have been imposed.

VI. CONCLUSIONS

The information collected on a smart grid is a library of personal information, the mishandling of which could lead to the invasion of consumer privacy. However, the exchange of information lies at the very heart of the promise of the smart grid—both its environmental benefit, and as a growing home for investment and innovation. Several regulatory tools are available to policy-makers, which can be employed to strike any balance among the various privacy, environmental, and economic risks associated with information control restrictions. Regulations seeking to protect consumer privacy must be careful not to unnecessarily hinder the deployment of smart grid technologies and so plant an obstacle in the nation’s path toward a new energy economy. Yet so too must they take care not to sacrifice consumer privacy amidst an atmosphere of enthusiasm for the project of electricity reform.

¹⁰⁵ See National Conference of State Legislatures (NCSL), *State Security Breach Notification Laws*, <http://www.ncsl.org/programs/lis/cip/priv/breachlaws.htm> (last visited Apr. 19, 2009) (stating that “[f]orty-four states, the District of Columbia, Puerto Rico and the Virgin Islands have enacted legislation requiring notification of security breaches involving personal information” as of Dec. 16, 2008).

¹⁰⁶ See CAL. CIV. CODE § 1798.29; NCSL, *Breach of Information*, <http://www.ncsl.org/programs/lis/cip/priv/breach.htm> (last visited Apr. 19, 2009).

¹⁰⁷ COLO. REV. STAT. § 6-1-716.

¹⁰⁸ See COLO. REV. STAT. § 6-1-716(1)(d). Cf. 4 COLO. CODE REGS. § 723-1-1004(t) (defining “personal information” as pertinent for provisions restricting utilities from sharing information regarding a customer’s network use, discussed *supra* Part IV.A).

APPENDIX A:
TECHNOLOGICAL BACKGROUNDER

Two research paths concerned with electricity consumption and load management are converging. The first of these is the empirical research and load monitoring carried out through the employment of devices such as non-intrusive appliance load monitors on single homes for the collection of population sample data. These devices allow electricity loads to be recorded once or even multiple times per second, providing very detailed information about a resident's electricity usage. Such devices and related research is important allow both for greater oversight (and so control) over the building's electricity usage and monitoring efficiency, as well as the development of extensive appliance load libraries, which can then be used to identify the load signals of specific appliances from within an aggregated load usage profile.

The second field of relevant research is the development of mathematical methods and use of artificial neural networks to glean detailed usage information from low-resolution interval data.¹⁰⁹ With the rapid installation of millions of smart meters across the country, and the potential for tracking and person's electricity usage beyond the walls of her own home—through, for example, the tracking of PHEV charges—these research efforts and the soon to be expansive data set housed at an electric utility could be used unveil the intimate details of millions of consumers' day-to-day life.¹¹⁰

As the interval of the data collected by smart meters decreases¹¹¹—thereby creating higher- and higher-resolution load profiles—and the ability to disaggregate low-resolution data into the specific appliance events that constitute it, we move closer and closer to the potential that electricity usage data will be a one-stop-shop for peering into the private activities of residential customers.

¹⁰⁹ See *supra* Part I.A.2.

¹¹⁰ See *supra* Part I.A.3.

¹¹¹ By “decreases” here, I do not mean a technological transition, but rather a policy shift on the part of the utility collecting the information. Many of the smart meters being deployed today can be readily set to collect usage information on one-minute intervals. Early on, this level of detail seemed unnecessary, and utilities usually opted to retrieve residential usage information every half hour. However, the trend has quickly moved toward shorter intervals. Indeed, in the span of researching this report, Xcel moved from collecting 15-minute interval data to 5-minute interval data in their “Smart Grid City.” Interview, Daniel Jones, Manager, Prices and Rates, Xcel Energy, Feb. 9, 2009.

i. Empirical Research and Real-Time Monitoring: The Non-Intrusive Appliance Load Monitor

The drive for high-resolution energy usage data from which to forecast load demand or optimize service led naturally to an investigation of individual appliances and their relative contribution—both in time and amount of draw—to the overall load. Such information had to be collected in the field.¹¹² Efforts to collect information were rather cumbersome and intrusive. Indeed, they often involved “a monitoring point at each appliance of interest and wires . . . connecting each to a central data-gathering location.”¹¹³ In effect, the appliance load monitoring methods employed “complex data-gathering hardware but simple software.”¹¹⁴

In the mid-1980’s, George Hart and Fred Schweppe turned the research on its head with the development of the non-intrusive appliance load monitor (NALM),¹¹⁵ which “reverses this balance[] with simple hardware but complex software for signal processing and analysis.”¹¹⁶ The NALM insight was simple in form, but profound in consequence: If a device could be appended to the existing metering infrastructure that would allow for real-time logging of electricity consumption (the simple hardware), the information of appliance use might be able to be reconstructed from the overall load data (through the application of complex software). This insight thereby removed the need for intrusion within the residential space and obviated the need for new equipment within the home.

Though initially thought a daunting task to work backwards from an appliance’s demand to the identity of the appliance itself, the load signatures of various appliance categories are surprisingly unique.¹¹⁷ The principle issue thus became the disaggregation of specific appliance

¹¹² Patent No. 4,858,141, Non-Intrusive Appliance Monitor Apparatus [hereinafter “NALM Patent”], col. 1, ll. 23–29 (filed Apr. 14, 1986) (“The energy consumption of any particular appliance can be measured readily in a laboratory, but this does not necessarily indicate the energy assumption of the appliance in typical use. For example, the energy consumption of a refrigerator in a household where the door may be frequently opened may be vastly different than under laboratory conditions.”).

¹¹³ George W. Hart, *Nonintrusive Appliance Load Monitoring*, 80 PROCEEDINGS OF THE IEEE 1870, 1871–72 (Dec. 1992).

¹¹⁴ *Id.* at 1870, col. 2. Though left out of the instant technical review, parallel research is underway which looks into industrial and commercial consumers of electricity in addition to the residential research outlined here. See, e.g., L.K. Norford & S.B. Leeb, *Non-intrusive Electrical Load Monitoring in Commercial Buildings Based on Steady State and Transient Load-Detection Algorithms*, 24 ENERGY & BUILDINGS 51 (1996).

¹¹⁵ Christopher Laughman et al., *Advanced Nonintrusive Monitoring of Electric Loads*, IEEE POWER AND ENERGY 56 (Mar./Apr. 2003). Non-intrusive appliance load monitors do not have a single, consistently used acronym throughout the research literature. As NALM was the one coined by the device’s inventor, it is the one I use throughout this paper. However, other researchers use NILM, NIALM, or NIALMS when discussing these devices. See, e.g. *id.* at 56–57 (NILM); Steven Drenker & Ab Kader, *Nonintrusive Monitoring of Electric Loads*, IEEE Computer Applications in Power 47 (1999) (NIALMS). For the sake of precision, it should be noted here that there are two basic forms of the NALM: the manual set-up NALM (MS-NALM) and the automatic set-up NALM (AS-NALM). The MS-NALMS require manual identification of appliance signatures through appliance monitoring and consumer interviews. See Hart, *supra* note 1 at 1870–72. I focus in this article on the AS-NALM, as its capabilities and development are more relevant to the instant discussion. Thus, the discussion *infra* which purports to explain the operation of a NALM is actually only examining the operation of an AS-NALM.

¹¹⁶ Hart, *supra* note 1, at 1871. See also Laughman, *supra* note 2.

¹¹⁷ See F. Sultanem, *Using Appliance Signatures for Monitoring Residential Loads at Meter Panel Level*, 6 IEEE TRANSACTIONS ON POWER DELIVERY 1380, 1380 col. 1 (1991). See also, *id.* at 1381 col. 2 (providing illustrative graphs of load signatures for a refrigerator, a washing machine motor, and a fluorescent light). This conclusion, arrived at by researchers nearly a generation ago, rested on an assumption of high-resolution data—an

load signatures from a household energy profile—that is, finding the load signal of a specific appliance amidst the noise of a whole household’s many energy draws.¹¹⁸ “The hardware handles edge detection and data communications, and software uses pattern-recognition algorithms to determine specific appliance usage.”¹¹⁹ When broken down, the process employed by the NALM to answer can be distilled into the following six steps:

- [1] *Installation and Data Recording*: the NALM is installed, usually at the power meter of the building,¹²⁰ to intercept load information. It receives the analog waveform data of consumer electricity draw, which is then normalized to adjust for supply-side variations.¹²¹
- [2] *Edge Detection*: the recorded information is examined for signal edges, that is, for those steep jumps or fall-offs in electricity draw that indicate the turning on, off, or cycling of a home appliance. In Figure 5, *infra*, the edges are the vertical steps in the energy profile.¹²²
- [3] *Cluster Analysis*: step events are plotted in “*p*-space,” a plot of real versus reactive power draws. Essentially, this means all the events are plotted according to two characteristics, how much energy they draw and how much energy they waste (or, more precisely, store and then return to the power source).¹²³ The step events are then organized into clusters of similar events (think: drawing lines around points that are close together on the scatter plot).¹²⁴ “Ideally, each cluster represents one kind of state change of one appliance.”¹²⁵
- [4] *Appliance Model Construction*: the clusters of step events are next organized into appliance models, which are mappings of an appliance’s various electricity draws when

assumption that is not always met in modern energy profile research, but which is becoming increasingly less important for the point’s validity. See discussion *infra*, Part III.B.2.

¹¹⁸ See Sultanern, *supra* note 4.

¹¹⁹ Drenker & Kader, *supra* note 2, at 50.

¹²⁰ See *id.* at 47 (“NIALMS electronics connect to the total load at a single point, usually the electric service entrance . . .”).

¹²¹ See Hart, *supra* note 1, at 1882.

¹²² See *id.*

¹²³ See *id.* at 1883. See also Drenker & Kader, *supra* note 2, at 48 (discussing scatter plots in “the complex power signature space.”). The concepts of real and reactive power in AC circuits are complicated and their details lie beyond the scope—and needs—of this paper. For our purposes, it is enough to understand that electricity flow along power lines oscillates, and so can be analogized to a person climbing up and down the ladder of a water tower. The work done in order to get up and then down the ladder is the “real power” in this analogy, while the water basin itself is the appliance. The higher towers are like energy-hungry appliances, and so measuring an appliance’s real power is roughly like counting the number of rungs on the ladder of the water tower. If the water basin at the top of the tower leaks, the person trudging up and down the ladder might carry a bucket of water up with him in order to keep the basin full. The amount of water dumped into the basin to be later let out through the leak—and not carried back down by our intrepid climber—maps onto the appliance’s reactive power in the analogy. See Peter W. Sauer, *What Is Reactive Power?*, A Power Systems Engineering Background Paper (Sept. 2003), available at http://www.pserc.wisc.edu/Sauer_Reactive%20Power_Sep%202003.pdf.

¹²⁴ There are a number of ways of performing the cluster analysis, and so grouping distinct events into categories to be identified as the repeated operation or state-change of a single appliance. See Hart, *supra* note 1, at 1883.

¹²⁵ See *id.* at 1883. See also Drenker & Kader, *supra* note 2, at 48.

operating in its various states, and the signals that will be observed as it transitions between states. Appliance models come in two basic types: on/off models, and finite state machine models. Simplified examples of each—using only real power signatures—are provided below.¹²⁶

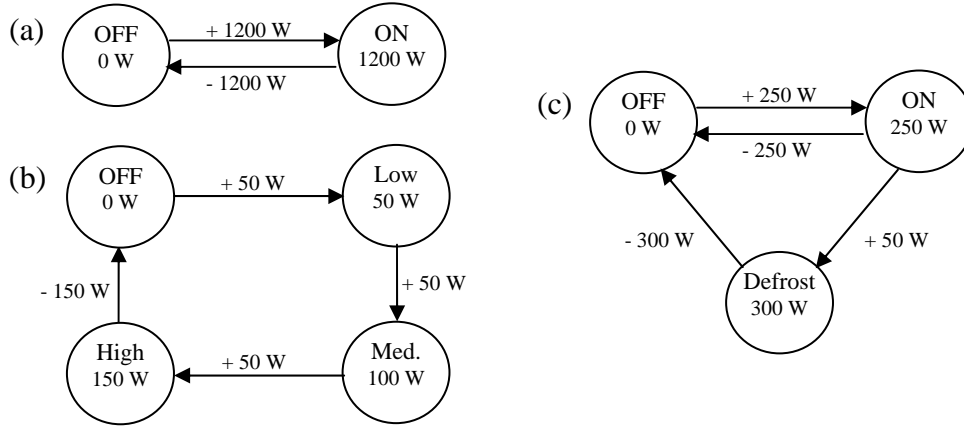

Figure 4: Appliance models for (a) “generic 1200 W two-state appliance, e.g., toaster”; (b) “three-Way lamp”; (c) “refrigerator with defrost state.”¹²⁷

[5] *Behavior Tracking*: using the appliance models constructed in step 4, appliance use is now tracked in real time as signals are identified as they appear rather than through later reconstruction.¹²⁸ Statistics are tabulated concerning each appliance’s use. While any number of statistical analyses are possible here, tracking the duration of appliance use is important to the next step in the NALM process. In the context of privacy concerns, it is worth noting some other kinds of tracking that could easily be performed at this stage: for example, an appliance’s frequency of use might be of interest to marketing departments

[6] *Appliance Naming*: once constructed, the appliance models are named so they can be recognized, not merely by the series of step events pulled from the energy profile, but as “washing machine,” “water heater,” “oven,” etc. For this, NALMs refer to a library of known appliance models, searching for the nearest match with those observed in the electricity profile.¹²⁹

¹²⁶ See Hart, *supra* note 1, at 1883.

¹²⁷ *Id.* at 1875. The appliance models here were reconstructed for this paper, but are for all intents and purposes identical to those originally provided by Hart.

¹²⁸ See *id.* at 1883.

¹²⁹ See *id.* at 1884; Drenker & Kader, *supra* note 2, at 49 (referring to this step as “appliance identification”). The libraries of appliance models are made obsolete as new appliances are introduced and extend their market penetration and others fall out of favor and out of home use. There is, however, a rich and ongoing line of research in the construction and upkeep of these libraries, as well as the development of taxonomies to ease their navigation and facilitate decision-making algorithms. See, e.g., H.Y. Lam & W.K. Lee, *A Novel Method to Construct Taxonomy of Electrical Appliances Based on Load Signatures*, 53 IEEE TRANSACTIONS ON CONSUMER ELECTRONICS 653 (2007); W.K. Lee et al, *Exploration on Load Signatures*, International Conference on Electrical Engineering, (2004); K.H. Ting et al., *A Taxonomy of Load Signatures for Single-Phase Electric Appliances*, POWER AND ELECTRONICS SPECIALIST CONFERENCE, IEEE (2005). Indeed, some researchers believe the compilation of and investigation into appliance load signatures is in many ways cornerstone to the entire endeavor. See W.K. Lee, *supra*. It is important to note here that not all libraries are made equal for our purposes, as the data contained therein may be tied to the resolution of the electricity load information used in its construction. Libraries of appliance

A number of heuristic principles are employed in order to ease the disaggregation of individual appliance signals from the noise of a household's total electricity consumption by framing a backdrop understanding of the total load. For example, the so-called "switch continuity" principle guides appliance naming by imposing the assumption that, generally, only one appliance switches on at a time, and that simultaneous appliance events are very rare.¹³⁰

Employing these procedures for data recording and analysis, a NALM is capable of providing utilities or researchers with detailed information about the electricity consumption habits of residents. Figure 5, below, shows a portion of individual's energy load profile that has been parsed by a NALM, each edge labeled with the corresponding appliance.

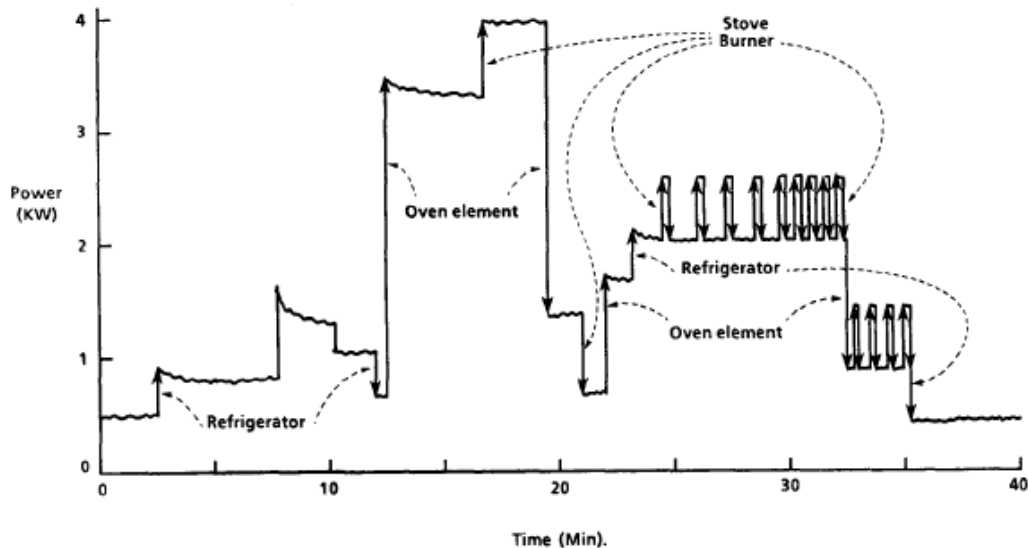

Figure 5: "Power v. time (total load) shows step changes due to individual appliance events."¹³¹

A remarkable number of electric appliances can be identified by their load signatures, and with impressive accuracy. Researchers have all but mastered identification of the larger common household appliances such as water heaters, well pumps, furnace blowers, refrigerators, and air conditioners, with recognition accuracies approaching perfection.¹³² Ongoing work focuses now on the myriad smaller electric devices around the home such as personal computers,¹³³ laser printers, and differentiating fluorescent from energy-saving light bulbs.¹³⁴ It also bears noting here that the success of this kind of load disaggregation is not limited to electric utilities; similar approaches have been successfully used to break down residential gas use into appliance events as well.¹³⁵

models that rely on 50 Htz appliance load signatures to identify individual appliances are not as useful if the data recorded at the meter is compiled in one second or one minute intervals.

¹³⁰ Hart, *supra* note 1, at 1874. Another such heuristic principle is the "zero loop-sum constant" which holds simply that the "sum of the power changes in any cycle of state transitions is zero." *Id.* at 1875.

¹³¹ *Id.* at 1871.

¹³² Drenker & Kader, *supra* note 2, at 50 (Table II).

¹³³ Ting et al., *supra* note 129.

¹³⁴ Lee et al., *supra* note 129.

¹³⁵ See M.L. Marceau & R. Zmeureanu, *Nonintrusive Load Disaggregation Computer Program to Estimate the Energy Consumption of Major End Uses in Residential Buildings*, 41 ENERGY CONSERVATION & MANAGEMENT

Zooming out from the relatively short time interval examined in Figure 5 helps bring the privacy concerns surrounding this kind of data collection and analysis better into focus. Figure 1 provides one household’s electricity profile over a 24-hour period with many of the appliance events labeled:

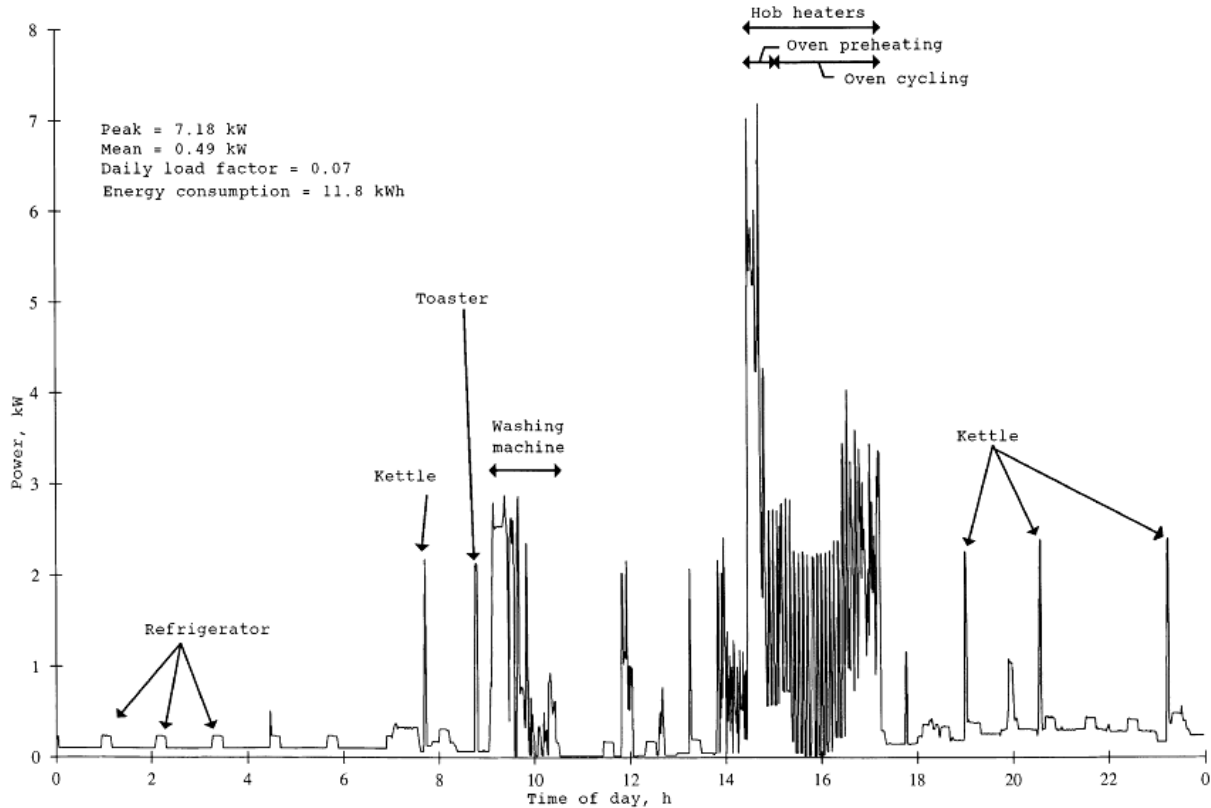

Figure 6: Household Electricity Demand Profile Recorded on a One-minute Time Base¹³⁶

Notably, the NALM potentially provides a better look into home activities that would peering through the blinds at that house. However, as initially conceived and commonly used, NALMs are installed on only a few homes with an eye to generalize from the specific observations to entire communities or appliance classes in order to tune load management operations and forecast future load needs.¹³⁷ To this end NALMs have been highly successful, with a number useful applications, including (1) supporting changes in rate structuring by allowing for measurement of electricity consumption in real-time as correlated with price shifts in electricity throughout the day, (2) “bill disaggregation” allowing for electric bills to be based on direct measurements rather than rough estimates, (3) “bill resolution” allowing companies to

1389, 1391 (2000) (citing S. Yamagami et al., *Non-intrusive Submetering of Residential Gas Appliances*, Proceedings of the ACEEE 1996 Summer Study on Energy Efficiency in Buildings 193 (1996)).

¹³⁶ G. Wood & M. Newborough, *Dynamic Energy-consumption Indicators for Domestic Appliances: Environment, Behavior, and Design*, 35 ENERGY AND BUILDINGS 821, 822 (2003) (citing M. Newborough & P. Augood, *Demand-side Management Opportunities for the UK Domestic Sector*, IEE Proceedings of Generation Transmission and Distribution 146 (3) (1999) 283–293).

¹³⁷ See NALM Patent, *supra* note 112, at col. 1, ll. 32–35 (“It is the energy consumption of appliance classes (e.g. all refrigerators or all water heaters), and their trends, that utilities are most interested in obtaining.”).

pinpoint sources of a consumer's high-bill complaints, and (4) "load diagnostics" facilitating analysis of whether a consumer's equipment is operating at its most efficient.¹³⁸

ii. Load Simulation and Detail Extraction from Low Resolution Data.

Another line of research has attempted to work backward from large data sets of aggregated electricity consumption information to glean more detailed usage information, as opposed to beginning with a single home's activities and working to generalize use patterns. The driving motivation here, once the many factors influencing overall electricity use are identified and accounted for, is to use them for the bottom-up construction of load simulations. By determining relevant factors such as weather patterns that influence customer electricity usage, and understanding exactly how those factors influence usage, one can roughly simulate future uses by checking to see which factors are or will be satisfied during any given period of interest.

At the outset, several different periodicities are readily recognizable when looking at aggregated electricity usage data. Consumption varies annually (as weather patterns cause consumer shifts in heating and air conditioning), weekly (as work schedules determine when consumers are at home to use their electric appliances, and to a certain degree what kinds of activities they'll engage in), and daily (as certain appliance uses tend to correspond with certain times of the day).¹³⁹ Each of these periodicities point to factors driving the social practices which in turn lead to electricity consumption, namely, the environment (seasonal patterns), economic obligations (work patterns), and the myriad diurnal routines and habits such as eating, watching television, cooking, etcetera. Thus, load simulations must account for these variables, anticipating increased use during times of extreme temperatures, weekends, and dinner time.

From this first insight follow a host of others, and new avenues for discerning factors that influence electricity consumption patterns. Different kinds of consumers will have different energy requirements, so teasing out the influence of social category on end use and electricity consumption can valuably inform load simulations which attempt to forecast use in areas with known demographics. For example, research has shown the differences in availability at home for various social types of electricity consumers including working adults, senior citizens, housewives, and children of school age.¹⁴⁰ Further research is being pursued which attempts to capture home availability in even richer colors, exploring patterns of at-home behavior and the predictability and success of interruptions to those routines.¹⁴¹ In addition to the type of user, differences in consumption vary with the type of activity, and profiles of energy uses that differentiate between activities can be constructed for things like leisure time, housework, cooking, personal hygiene.¹⁴² These profiles of both user types and activity types can then be compared to an individual's load profile using probabilistic algorithms to determine their membership to the various social typologies and frequency of engagement in various

¹³⁸ Drenker & Kader, *supra* note 2, at 50–51.

¹³⁹ See S.F. Ghaderi et al. *Forecasting Electricity Consumption by Separating the Periodic Variable and Decompositions the Pattern* [sic], 2007 IEEE Int'l Conference on Industrial Engineering and Engineering Management 292 (Dec. 2007).

¹⁴⁰ A. Capasso et al., *Probabilistic Processing of Survey Collected Data in a Residential Load Area for Hourly Demand Profile Estimation*, 2 Athens Power Tech 866, 868 (Sept. 1993) (Proceedings: Joint International Power Conference).

¹⁴¹ Kristine S. Nagel et al., *Predictors of Availability in Home Life Context-Mediated Communication*, 6 CHI LETTERS 457 (Nov. 2004).

¹⁴² Capasso, *supra* note 140, at 869.

activities.¹⁴³ These algorithms can then be paired with data regarding the market penetration of various appliances to improve accuracy their accuracy.¹⁴⁴

Demand forecast systems utilizing this type of analysis predicted loads through a method of triangulation of sorts, drawing from data about who would in the residence at various times, what kinds of things they might be doing, and what load those things would likely require. While statistical modeling of this sort can be sophisticated and highly accurate for certain purposes, the most efficient and responsive energy management systems (and most accurate energy profile profiling mechanisms) must grow from more detailed data.

iii. Convergence: Household Usage Habits Gleaned from Advanced Metering Infrastructure.

The ongoing distribution of smart metering technology¹⁴⁵ provides a wealth of data that, while less detailed in its data-logging than most NALMS,¹⁴⁶ is still far more detailed than the survey data generally relied upon for the probabilistic modeling of loads based on social class and activity type. The question remains: just what can be discovered by looking into an energy profile constructed from smart meter data-logging?

In many ways, smart meters provide enough information to skip out on the need for NALM hardware.¹⁴⁷ Commercially available smart kWh-meters can be readily modified to sample at small enough intervals to be useful in the application of analytics developed for NALM.¹⁴⁸ Where gaps remain, information about the market penetration of various appliances can be used to fill them in, improving the accuracy of the appliance identification in much the same way as was done with those predicting loads by profiling energy profiles above.¹⁴⁹

An Italian study reported in 2002 used fifteen-minute interval data—the same resolution collected by most smart meters today—to identify heavy-load appliance uses within an electricity usage profile.¹⁵⁰ Researchers there were able use artificial neural networks to pinpoint the use of washing machines, dishwashers, and water heaters with accuracy rates of over 90 percent from within the noise of the aggregated load information.¹⁵¹ As libraries of load signatures expand and more research pours into similar efforts, the details extractable from smart meter data will become richer. Add to this the fact that many smart meters are able to record at higher rates, and the capabilities for gleaning highly detailed information about household activities from the data only increases. Efforts in such a vein—as with NALMs—focus on the development of sophisticated software. Once the relatively simple hardware for data collection

¹⁴³ See generally *id.*

¹⁴⁴ See Jukka V. Paatero & Peter D. Lund, *A Model for Generating Household Electricity Load Profiles*, 30 INT’L J. ENERGY RESEARCH 273, 274, 277–79 (2005).

¹⁴⁵ See *supra* Part II.B.

¹⁴⁶ See *supra* Part I.A.1.

¹⁴⁷ See Hannu Pihala, *Non-intrusive Appliance Load Monitoring System Based on a Modern kWh-Meter*, VTT Publication 356, Technical Research Centre of Finland (May 1998), available at <http://www.vtt.fi/inf/pdf/publications/1998/P356.pdf> (illustrating that a modern “kWh-meter can be used at the same time for billing, power quality[,], and appliance end-use monitoring.”)

¹⁴⁸ See *id.* at 16.

¹⁴⁹ A. Prudenzi, *A Neuron Nets Based Procedure for Identifying Domestic Appliances Patern-of-Use from Energy Recordings at Meter Panel*, IEEE Power Engineering Society Winter Meeting 941, 942 col. 1 (2002).

¹⁵⁰ See *id.*

¹⁵¹ See *id.* at 946 col. 1.

is in place, resolving the picture of household activities found within electricity usage profiles becomes a matter only of data analysis—and the development of analytic tools continues.

In sum, all the steps involved in NALM analysis discussed in Part I.A.1 can be run with the data collected by smart meters. While the data recorded by smart meters is lower in resolution, inductive algorithms and mathematical methods are quickly filling the gaps. Importantly, smart meters will provide information on millions of consumers as meter replacement efforts are in full swing across the country—this in contradistinction with the few and usually consenting consumers under the watch of NALMs. The result: highly detailed information about activities carried on within the four walls of the home will soon be readily available for millions of households nationwide. What’s more, the sheer volume of the research and development in this area helps understand the field as a vector, one that points directly at more and more-detailed information collected concerning the activities of millions of people. While the motivations for this aggregation of data may be noble, the potential for serious privacy invasion is only growing, and so the need for care.

APPENDIX B:
DATA USES & POTENTIAL THIRD PARTY INFORMATION CUSTOMERS

A number of “edge services” have already grown up around smart-metered information, and several more are readily foreseeable.¹⁵² The following is a brief discussion aimed at illustrating the breadth of the market for services surrounding the collection and analysis of usage data to enable the smart grid. It is likely that not all of these potential markets will materialize, in part due to the natural development of the information trade, and in part due to the development of the regulatory landscape over which the market is laid. However, it is worth noting that the information available through the analysis of high-resolution electricity usage profiles is unique in both breadth and depth. It allows insight into entire lifestyles and routines, and at heretofore unprecedented scales. As such, the following list should be seen as attempting to introduce a few of the principle focuses surrounding smart grid information collection and dissemination, and not as an exhaustive exploration of the space.

i. Efficiency Analysis and Investment

High-resolution electricity usage information can be useful in spotting energy sinks within homes and office buildings, and so directing efficiency investments. Roy Palmer of Xcel Energy tells a story about giving a tour of their SmartGridCity control center to various interested parties. Upon request, controllers pulled up the usage profile of one of the people on the tour. To her surprise, the woman discovered that her hot tub heater pump was turning on frequently throughout the day and drawing a massive amount of electricity relative to the rest of her load.¹⁵³

As this example shows, a smart-meter-constructed electricity usage profile lays bare high-using appliances, thereby pinpointing opportunities for energy savings. Armed with such information, the customer could respond in a number of ways. Most simply, she could manually

¹⁵² For a good list of companies entering the fringe services and electricity management space, see Lynne Kiesling, *Intelligent End-Use Devices Make a Transactive Smart Grid Valuable (Part 3 of 5)*, Knowledge Problem.com, Mar. 4, 2009, <http://knowledgeproblem.com/2009/03/04/intelligent-end-use-devices-make-a-transactive-smart-grid-valuable-part-3-of-5/>.

¹⁵³ See *infra* note 173.

manage her load, e.g., turn her hot tub off when she went to work, and on when she arrived back home. While this most basic form of demand-side management does not cost anyone anything (except the electric utility that loses the electricity sales), there is also room for businesses to grow in this decision space. Efficiency consultants could support consumer decision-making to help manage the appliance use in ways that would not sacrifice quality of life. Indeed, efficiency consultants have already approached the Colorado Public Utilities Commission inquiring after their ability to purchase the usage information captured by Xcel's smart grid program in Boulder, CO.¹⁵⁴ Part of this management plan may well be investing in timers, remote kill switches, or other energy management and automation devices to tailor the load to match the customers price and usage preferences.¹⁵⁵ Finally, the information wouldn't just be useful to those property owners or managers that have the money to invest in savings. Energy performance savings contracts (EPSCs) are financing mechanisms that allow third parties—energy service companies (or ESCOs)—to design and install efficiency measures and pay for the service out of the savings.¹⁵⁶ The threshold step in EPSCs is an energy audit, and the huge growth in the ESCO industry over the last few years means that large, corporate ESCOs (as opposed to door-to-door efficiency salesmen) will be seeking out smart metered usage data to fine tune their retrofit strategies.

Thus, the high-resolution usage data would be invaluable at every step in the efficiency retrofit process: (1) the identification of potential customers, (2) pinpointing energy sinks and areas for improvement, and (3) developing the retrofit strategy and directing efforts toward projects with relatively high ratios of energy-savings to dollars spent.

ii. Home Efficiency Monitoring

A home efficiency monitoring service provider, potentially the electric utility itself, would not only pick out various appliance events from within a customer's load profile, it would monitor that appliance's performance. Were, say, a residential customer's washing machine to be operating below spec and so wasting energy, the efficiency monitoring service provider would notify the customer that maintenance was necessary. The notice could even conceivably contain a projected cost-over-time of the ill-performing device so that the customer could compare replacement and maintenance costs with the costs of inaction or delayed action.¹⁵⁷

iii. Web Portals for Load Management

Another space for developing a business based on smart grid-collected information is in the development of a web portal or other software that allows customers to see and even directly manage their own load profiles.

Xcel Energy is developing a web-based application to allow customers connected to their smart grid to see their own load profiles, thereby supporting demand-side management efforts

¹⁵⁴ Email communication with Barbara Fernandez, Chief of Staff, Colorado Department of Regulatory Agencies, Colorado Public Utility Commission, Jan. 20, 2009.

¹⁵⁵ See the discussion of smart appliances and automation devices, *infra* Parts II.B.iv and .v.

¹⁵⁶ See Energy Service Coalition, *What Is Energy Performance Contracting*, <http://www.energyservicescoalition.org/resources/whatis.htm> (last visited Mar. 30, 2009); State of Washington, General Administration, <http://www.ga.wa.gov/eas/epc/whatis.htm> (last visited Mar. 30, 2009).

¹⁵⁷ This concept was sketched out to me in a personal conversation with Ray Gogel, Chief Administrative Officer at Xcel Energy, Mar. 3, 2009.

and facilitating load-shifting and load-shaving.¹⁵⁸ However, electric utilities are not the only ones interested in this space. Third party developers have expressed an interest in entering the web portal market, to the extent that it is or will be a market.¹⁵⁹ Most notably, Google announced its entrance into smart grid information management in February of 2009.¹⁶⁰ Google’s concept description for its “PowerMeter” project illustrates its reliance on smart-meter-generated data:

[The] Google PowerMeter, now in prototype, will receive information from utility smart meters and energy management devices and provide anyone who signs up access to her home electricity consumption right on her iGoogle homepage. The graph [below] shows how someone could use this information to figure out how much energy is used by different household activities [sic].¹⁶¹

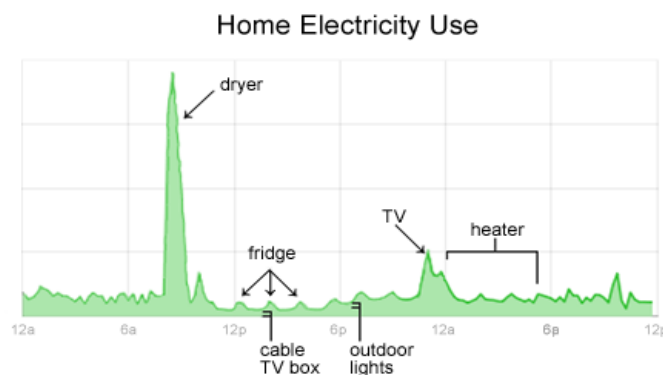

Figure 7: Google’s PowerMeter concept.¹⁶²

Such web portals are critical if the smart grid is to realize its potential for efficiency gains, but the just who will provide the service to the electricity customer—and how the cost of that service will be recovered—is yet to be determined.¹⁶³

iv. Smart Appliances

Several companies are developing “smart appliances” that can tap into price signals sent from the electric utility and allow consumers to automate their appliance use depending on

¹⁵⁸ See *infra* note 173. See also *Xcel Energy Smart Grid: A White Paper*, at 10, available at <http://smartgridcity.xcelenergy.com/media/pdf/SmartGridWhitePaper.pdf> (“The Web interface will give customers an opportunity to automatically control their energy. Customers will be able to choose to turn devices on or off from pre-selected preferences (for example, hourly price points or green energy signals sent from the Web.)”)

¹⁵⁹ Positive Energy appears to be developing software to this end, though whether it will be web-based or more traditional sold-software in format is unclear. See Positive Energy, *AMI Analytics*, <http://www.positiveenergyusa.com/products/analytics.html> (last visited Mar. 29, 2009)

¹⁶⁰ Matthew Wald & Miguel Helft, *Google Taking a Step into Power Metering*, N.Y. TIMES, Feb. 9, 2009, available at <http://www.nytimes.com/2009/02/10/technology/companies/10grid.html?ref=technology>. Google’s description of its PowerMeter and its interest in the smart grid information space is set out at Google.org, *Energy Information Home*, <http://www.google.org/powermeter/index.html> (last visited Mar. 21, 2009).

¹⁶¹ Google, *Google.org Energy Information: What Google Is Doing*, <http://www.google.org/powermeter/howitworks.html> (last visited Mar. 27, 2009).

¹⁶² *Id.*

¹⁶³ Issues surrounding this business model are taken up further *infra* Part IV.B.

electricity costs. The appliance settings can be adjusted by the appliance owner (and electricity customer) to respond—either automatically or through remote switching by the electric utility—to dynamic price signals and other demand response information. Such appliance developers include, both new and specialized companies such as EcoBee and EnergyHub,¹⁶⁴ as well large incumbent appliance manufacturers such as General Electric¹⁶⁵ and Whirlpool,¹⁶⁶ both of which have or are developing multiple smart appliance products.

v. Home Automation and Home Area Networks

Home-area networks (HANs) allow for even more control over energy consumption than the mere implementation of advanced metering devices and web portals or other communication devices.¹⁶⁷ Where a smart meter would allow customers to see the details of the load, and so facilitate manual efforts to manage that load, home-area networks take the next step to integrate the various loads into a single electricity portfolio, and allow for single sight management and automation of that diverse portfolio.¹⁶⁸ Rather than managing each smart appliance separately, an integrated load management strategy could be formulated and implemented from a single source.

As with the web portal developers, the business models surrounding HAN development and installation have yet to fully mature. While there is potential to develop a model for service provision directly to electricity consumers, much of the focus thus far has been on providing the electric utilities with HAN control. When CURRENT deployed the nation's first HANs in TX, the electric utility, subject to the customer's permission,

¹⁶⁴ See EcoBee, <http://www.ecobee.com/> (last visited Mar. 29, 2009) (programmable thermostats) and EnergyHub, <http://www.energyhub.net/Home.html> (last visited Mar. 29, 2009) (electricity usage information communication systems), respectively.

¹⁶⁵ Press Release, General Electric, GE Not Only Produces Appliances that are Energy Efficient, but Will Now Introduce Innovative Products that Efficiently Consume Power More Intelligently, Mar. 4, 2009, *available at* http://www.geconsumerproducts.com/pressroom/press_releases/company/company/ge_estaraward_2009.htm (“In the first Quarter of 2009, GE will introduce a suite of “smart” appliances or Energy Management Enabled Appliances. These GE appliances will be enabled to receive a signal from the local utility companies that are participating in tiered rate programs to help consumers manage their peak energy usage.”).

¹⁶⁶ See Hank Marcy (Vice President of Technology for Whirlpool), *Smart Appliances for the Smart Home*, <http://www.metering.com/node/14528> (last visited Mar. 29, 2009) See also Patent No. 7,110,832 B2, Energy Management System for an Appliance (filed Oct. 23, 2002) (describing a system that could be installed in a number of different appliances to allow for automated management of appliance events determined by electricity price signals).

¹⁶⁷ See Federal Energy Regulatory Commission, Assessment of Demand Response & Advanced Metering 2007, Staff Report [hereinafter “FERC 2007 Demand Response Assessment”], at 26, *available at* <http://www.ferc.gov/legal/staff-reports/09-07-demand-response.pdf>.

¹⁶⁸ See Federal Energy Regulatory Commission, Assessment of Demand Response & Advanced Metering 2008, Staff Report [hereinafter “FERC 2008 Demand Response Assessment”], at 14, *available at* www.ferc.gov/legal/staff-reports/12-08-demand-response.pdf (“A home-area network ‘is a network contained within a user’s home that connects a person’s digital devices, from multiple computers and their peripheral devices to telephones, VCRs, televisions, video games, home security systems, ‘smart’ appliances, fax machines and other digital devices that are wired into the network.’ Integration between home-area networks and advanced metering systems allows an entity to provide information to customers and remotely manage large loads (such as air conditioning and electric heat.)” (quoting *What is HAN?* (Aug. 28, 2008), *available at* <http://www.webopedia.com/TERM/H/HAN.html>).

controlled home thermostat settings.¹⁶⁹ GridPoint is another company developing automation network devices and software for load management. At the moment, their systems grant control over appliance events to electric utilities in the first instance¹⁷⁰ with secondary “opt-out” control extended directly to the electricity customer.¹⁷¹

vi. Information Network Development

There is also money to be made in the development of the information networks that will support the smart grid, either through the construction of a new network or via the provision of a new service on an existing network. The potential tie to existing broadband and telecommunications networks is a natural one as the very concept of a smart grid is, fundamentally, one of data collection and analysis, and information management; at its heart, the smart grid is a communications network.¹⁷²

For its SmartGridCity project in Boulder, Colorado, Xcel Energy is laying its own fiber to facilitate the transmission of metering information back to the utility and, eventually, the sending of dynamic price signals (potentially as often as every five seconds) to the consumer (or at least the consumer’s energy automation system).¹⁷³ The last mile of this network is utilizes broadband over power line transmission (BPL), and a fiber back-haul network has been deployed for this application. Xcel’s future deployments of smart grid technologies will likely rely on wireless data transmission for the last mile in order to cut down on installation costs.¹⁷⁴

However, developing its own network to support this information traffic is cost-prohibitive for anything other than the Boulder proof-of-concept project. Anticipating this cost bottleneck, Xcel Energy approached Quest, the area’s telecommunications service provider, in hopes of developing a partnership to piggy-back smart grid information onto an existing broadband network. While the companies were not able to make a deal at this early juncture, and the common wisdom was that some sort of “regulatory blessing” would be needed in order to finalize such a partnership and navigate the disparate service mandates under which the two

¹⁶⁹ Reuters, *CURRENT Deploys the First Real-Time Utility Home-Area Network (HAN) in the Nation*, <http://www.reuters.com/article/pressRelease/idUS182515+22-Jan-2008+PRN20080122> (last visited Mar. 13, 2009). (describing utility-controlled thermostat installations).

¹⁷⁰ *Load Management*, GridPoint, <http://www.gridpoint.com/solutions/loadmanagement/> (last visited Mar. 23, 2009) (“The GridPoint Control Console provides utilities with direct control to reduce load in real-time or through scheduled events. The control console can be accessed from a utility’s control room or integrated within a utility’s energy management system.”)

¹⁷¹ *See id.* (“Customers can easily ‘opt out’ of a specific event either through GridPoint’s online energy management portal or in the case of a temperature adjustment, directly from their thermostat.”).

¹⁷² *See* Roy Palmer, *SmartGridCity: Xcel Energy’s Bold Step Toward a Next-Gen Smart Grid*, Electric Light & Power, http://uaelp.pennnet.com/display_article/339011/22/ARTCL/none/none/1/SmartGridCity:-Xcel-Energy%E2%80%99s-Bold-Step-Toward-A-Next-Gen-Grid/ (last visited Mar. 11, 2009) (“The fundamental component that ties smart grid together is a robust and dynamic communications network that provides for instant two-way communication and interaction throughout the grid.”).

¹⁷³ The information presented in this and the following paragraph was obtained in a meeting with Xcel Energy’s Roy Palmer, Executive Director of Government and Regulatory Affairs, held with the staff of the Colorado Public Utilities Commission on the morning of March 5, 2009.

¹⁷⁴ *See supra* note 173; *see also* Palmer, *supra* note 172, (“The primary means of communication across SmartGridCity will be broadband over power lines, or BPL Nearly 90 percent of the city will be connected with BPL, although the company also plans to test wireless capabilities in parts of the network as well.”) (quoting Randy Huston, SmartGridCity Project Delivery Executive, Xcel Energy).

utilities operated, Xcel remained hopeful that a partnership could be established for future smart grid operations.¹⁷⁵

Other partnerships for developing a smart grid information network are forming. Most recently, AT&T “announc[ed] a partnership with smart metering manufacturer SmartSynch to offer a service plan for utilities trying to establish smart grid technology.”¹⁷⁶ SmartSynch, a hardware manufacturer deeply involved with PG&E’s transition to smart grid systems,¹⁷⁷ will transmit smart metered data over AT&T’s wireless networks.¹⁷⁸

vii. Insurance Adjustment

At its most fundamental level, insurance sales is a probability game, and statistical correlation and analysis is the coin of the trade. Insurance companies use all kinds of information with underwriters tapping into virtual warehouses of statistics to assess future risks and set rates and making adjustments. Anticipating how the availability of new information will influence insurance rates and adjustments is a difficult, but the wealth of information available in household electricity usage profiles is undeniable.¹⁷⁹

In the abstract, though, there are two ways in which insurance companies might make use of smart grid information. First, a company might mine the data pool for statistical correlations in order to adjust rates. This could potentially shift the insurance landscape and the things that insurance companies care about; imagine, for example, if statistical analysis unveiled a robust correlation between a individual’s number of automobile accidents and the number of hours of television he watched in a given week, or perhaps between certain kinds of health risks and a person’s microwave usage. The second way in which an insurance company might use smart grid information is in monitoring the behavior of insured individuals. Auto insurance companies get continual updates relating regarding customer driving records, and adjust premiums after run-

¹⁷⁵ See *supra* note 173.

¹⁷⁶ Dan Bradbury, *Smart Metering Firms Get Ready to Roll*, Business Green, Mar. 20, 2009, <http://www.businessgreen.com/business-green/news/2238882/smart-metering-firms-ready-roll> (last visited Mar. 21, 2009).

¹⁷⁷ See, e.g., SmartSynch, *Case Study: Pacific Gas and Electric Company’s Implementation of the SmartSynch SmartMeter System*, available at http://www.smartsynch.com/pdf/PGEcasestudy_000.pdf.

¹⁷⁸ As long as smart grid information management and trade remain ancillary to the purpose of electricity provision for an electric utility, such networks are likely to be viewed as private networks facilitating the utility’s operations. However, were the business models of electric utilities to undergo a paradigm shift toward one of information management (say, even electricity network switch became decentralized and the principle purpose of the electric utility was to facilitate information transfer and so efficient management), there is at least a colorable argument that such activities would fall under the Federal Communication Commission’s Title I—or even Title II—authority under the Communications Act of 1934 to regulate the collection and disclosure of personal information related to information or telecommunication services. See 47 U.S.C. §§ 153 (defining “telecommunications service and other relevant terms in determining jurisdictional scope), 222 (setting out guidelines and definitions for the protection of customer proprietary network information (CPNI)); Nat’l Cable & Telecom. Ass’n. v. Brand X Internet Services, 545 U.S. 967, 996–999 (2005) (interpreting “telecommunications” as defined in the Communications Act of 1934 and focusing on the “transparency” or un-processed nature of the information transmission). At the moment, though, such a shift seems little more than an academic thought experiment.

¹⁷⁹ For a discussion of how new information can change the insurance game—both in rate setting and in individual decisions about when to acquire insurance—see Mattias K. Polborn, Mike Hoy, & Asha Sadanand, *Information and Dynamic Adjustment in Life Insurance Markets*, Working Paper (Oct. 1999) available at <http://economics.uwo.ca/econref/WorkingPapers/researchreports/wp1999/wp9911.pdf> (discussing newly available information from derived from the Human Genome Project and its potential impacts on the life insurance industry).

ins with the law even when no insurance claim is filed (say in the case of getting a speeding ticket). Similarly, one can imagine insurance companies adjusting, for example, auto insurance premiums if they discover that, for the last month, you have averaged less than 6.5 hours of sleep each night—information that could be gleaned from careful study of an electricity usage profile—and that puts you in a greater risk category for having an automobile accident.

viii. Marketing and Market Research

Smart grid information also has many potential uses in marketing and market research. First off, peaking into the daily uses of millions of electronic appliances will provide a great deal of information about market penetration of various devices, usage habits, and even expose new areas for market development. Beyond just informing market analysts, though, it could enable a whole new kind of targeted advertising. When presenting before the Colorado Public Utilities Commission, Comverge Senior Vice President Tom Van Denover noted that resident's with underperforming appliances could be targeted by utility "partners"—essentially favored appliance manufacturers having some previously established relationship with the smart grid development in a given region.¹⁸⁰ Advertisements could be tailored to specific home use habits, and even delivered at times when customers were known to be home. Telemarketers and door-to-door sales operations could use real-time electricity usage information to discover when potential clients were at home and so target their efforts more effectively.

ix. National Security and Law Enforcement

Law enforcement already uses electricity usage information for investigative purposes.¹⁸¹ Heavy loads can indicate marijuana growing operations or other drug manufacturing.¹⁸² Furthermore, in a security-conscious atmosphere post 9/11, several government agencies have capitalized on existing information markets to gain insight into individuals' behavior and verify an individual's identity.¹⁸³ Law enforcement agencies contracted with so-called data brokerage firms to gather as much personal information on individuals as they could:

Law enforcement . . . has found data brokers useful, as these private companies maintain and organize personal information on individuals in a manner that may not be legally available to government actors. The Privacy Act, for example, requires federal agencies to limit the amount of information on American citizens that these agencies maintain and disseminate.¹⁸⁴

¹⁸⁰ Informational meeting with Colo. PUC Commissioners and staff concerning smart grid technologies, Apr. 9, 2009.

¹⁸¹ See, e.g., CAL PENAL CODE § 1326.1 (allowing law enforcement agents to subpoena utility records, as well as electric utilities to hand over records to law enforcement authorities voluntarily).

¹⁸² See, e.g., Pat Minelli, *High Electric Bill Leads to Marijuana Bust*, SHAKOPEE VALLEY NEWS, Sept. 30, 2006, available at <http://www.shakopeenews.com/node/722>.

¹⁸³ See CRS Report RS22137, *Data Brokers: Background and Industry Overview*, Nathan Brooks (May, 2005), at 1–2 (citing, *inter alia*, Robert O'Harrow, Jr., *In Age of Security, Firms Mine Wealth of Personal Data*, WASH. POST, Jan. 20, 2005, at A1).

¹⁸⁴ *Id.* at 2 (internal citations omitted). See also Glenn R. Simpson, *FBI's Reliance on the Private Sector Has Raised Some Privacy Concerns*, WALL ST. J., Apr. 13, 2001. Data brokers are further discussed, *infra* Part III.C.

In 2005, then-forerunner of the data brokerage industry ChoicePoint had a multi-million dollar contract with the Department of Justice and even hosted agency-specific web portals.¹⁸⁵ If made available to them, there is no reason that smart grid information would not also draw substantial interest and money from such agencies. The wealth of information derivable from high-resolution electricity usage profiles¹⁸⁶ would make smart meter information a valuable commodity to law enforcement personnel.¹⁸⁷

¹⁸⁵ CRS Report RS22137, *supra* note 183, at 4. ChoicePoint has since been purchased by another data brokerage giant, LexisNexis. The firm's "Government Solutions" web page is accessible at <http://www.choicepoint.com/government/index.html> (last visited Mar. 29, 2009). For a complete list of the firm's information services, see <http://www.choicepoint.com/products.html> (last visited Mar. 29, 2009).

¹⁸⁶ Described *supra* Part I.A.

¹⁸⁷ It is unclear whether a law enforcement agency's subscription to electricity usage information would be allowed under existing Fourth Amendment jurisprudence. In many ways, the information made available through analysis of electricity load profiles pierces the blinds and allows insight into in-home activities. The Supreme Court has addressed such an issue in the context of thermal imaging technology: "In the home, our cases show, all details are intimate details, because the entire area is held safe from prying government eyes." *Kyllo v. United States*, 533 U.S. 27, 27 (2001). Thus, under one reading, law enforcement agencies might be required to obtain a warrant before being allowed to scour high-resolution electricity records. It should be noted, though, that the Court's reasoning in *Kyllo* relied at least in part on the fact that thermal-imaging technology was not readily available and thus the law enforcement officer's techniques seemed even further from "naked-eye surveillance." *Id.* at 34-40. In the context of smart meter technology, massive deployment efforts would almost certainly render the technology "readily available," which may cut against Fourth Amendment protections. See FERC 2008 Demand Response Assessment, *supra* note , at 14 (reporting that, all told, such deployment efforts nationwide will result in the installation of 52 million smart meters over the next five to seven years, likely leaving only about a third of American meters without an upgrade).